

Visual Selection Guide

ROBOHAND | Grippers, Slides, Rotaries



ABOUT DESTACO

Built on a Strong Foundation



Grippers, Rotaries and Linear Slides

Indexers, Positioners, and Conveyors



End Effectors and Vacuum Products



Manual and Pneumatic Clamps



Remote Handling and Containment

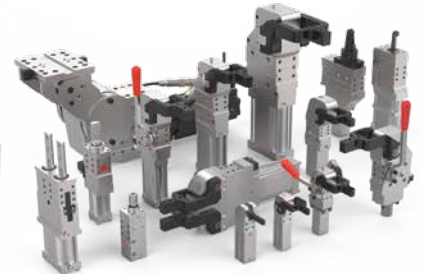

Power Clamping and Locating

DESTACO, a Dover company, is a global leader in the design and manufacture of high-performance automation, workholding and remote-handling solutions. The company serves customers in a variety of end-markets, including the automotive, life sciences, consumer packaged goods, aerospace, industrial and nuclear sectors.

Built on a legacy of more than 100 years, DESTACO offers a comprehensive portfolio of products designed to engineer precise movement, placement and control solutions that drive productivity and uptime for manufacturers around the world. The DESTACO family of products consists of industry-leading brands such as DESTACO Manual Clamps, Power Clamps, and End Effectors; CAMCO™ and Ferguson™ Indexers; Robohand™ Grippers; and CRL™ Manipulators and Transfer Ports.

DESTACO is based in Auburn Hills, Michigan, U.S.A. The company has more than 800 employees with 13 locations, in 9 countries, across the Americas, Europe and Asia.

DESTACO is part of Dover Corporation, a diversified global manufacturer with annual revenues of \$7 billion. The company delivers innovative equipment and components, specialty systems and support services through four major operating segments: Energy, Engineered Systems, Fluids, and Refrigeration & Food Equipment. Headquartered in Downers Grove, IL, (NYSE: DOV)

More information is available at destaco.com and dovercorporation.com

Focusing all our Resources

New Product Development

DESTACO has dedicated resources to design and build the next generation of products and solutions

Customer Service and Technical Support

DESTACO has industry leading global support to address any product and application concerns you may have

Design Tools

DESTACO provides an extensive CAD library, sizing software, and online tools to support our global customers



Our Insight Working for You

Application Engineering

We utilize our expertise and complete portfolio of products to create solutions that fit our customers' needs and applications

Custom Solutions

if our off-the-shelf solutions don't fit, we will partner with our customers to develop products that will



Grippers, Rotaries, and Linear Slide Solutions

Engineered Reliability

DESTACO's Robohand products are engineered for reliability and long life to ensure maximum production uptime. These products are designed and machined for precise repeatability with minimal maintenance.

Markets











Applications



GRIPPERS/SLIDES/ROTARIES

Table of Contents

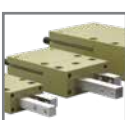
	OEM Machine Builder Products.....	10
	Electric Grippers.....	14
	Precision Grippers.....	16
	General Industrial Grippers.....	24
	Heavy Duty Grippers.....	38
	3-Jaw Parallel Grippers.....	42
	Specialty Grippers.....	49
	Angular Grippers.....	50
	Rotary Actuators.....	54
	Linear Slides.....	60
	Feed Escapements.....	70

CLEAN ROOM RATED SOLUTIONS

Grippers/Slides/Rotaries | Product Overview

DESTACO's Clean Room Rated Solutions are geared toward laboratory, semiconductor, medical, and food handling type environments. Many of our pneumatic products include a scavenge or purge port. These extra ports create internal vacuum or pressure to control contaminants escaping into the environment or prevent de-greaser or other chemicals penetrating our product.

Solutions include:

- Diverse line-up of products for class 10/100 cleanroom environments
- Manufactured with corrosion-resistant materials for use with de-ionized water
- Customized solutions available with food and medical grade lubricants, stainless steel, and nickel-plated materials to meet your application requirements.

Electric Parallel Grippers			
Rating	RPE-100	DPE-200	DPE-400
10	☉		
100	☉		☉
1000	☉	☉	☉
10000	☉	☉	☉
100000	☉	☉	☉

Pneumatic 2-Jaw and 3-Jaw Grippers									
Rating	RPMC	RPLC	DPDS	DPDL	DPG	DPP	RDH	RTH	DCT
10	☉	☉	☉						
100	☉	☉	☉	☉	☉		☉	☉	☉
1000	☉	☉	☉	☉	☉		☉	☉	☉
10000	☉	☉	☉	☉	☉	☉	☉	☉	☉
100000	☉	☉	☉	☉	☉	☉	☉	☉	☉

Rotary Actuators			
Rating	DRG	DRF	RR
10			
100	☉	☉	
1000	☉	☉	
10000	☉	☉	
100000	☉	☉	☉

Linear Slides			
Rating	DLB	DLT	DLM
10			
100			
1000	☉	☉	☉
10000	☉	☉	☉
100000	☉	☉	☉

☉	Standard Clean Room
☉	With use of Scavenge Port

Note: All products tested using Krytox™ Grease. Please contact factory for individual test results and additional clean room requirements.

MODULAR MOUNTING SOLUTIONS

DESTACO's modular automation systems feature DIRECTCONNECT™ technology, allowing all components of the system—base slides, block thrusters, thruster slides, grippers, and mounting stanchions—to be mounted together quickly and easily without any adapter plates.

- Reduces engineering design
- Saves \$\$\$ with modular solutions
- Change device orientations quickly
- Eliminates Adapter Plates

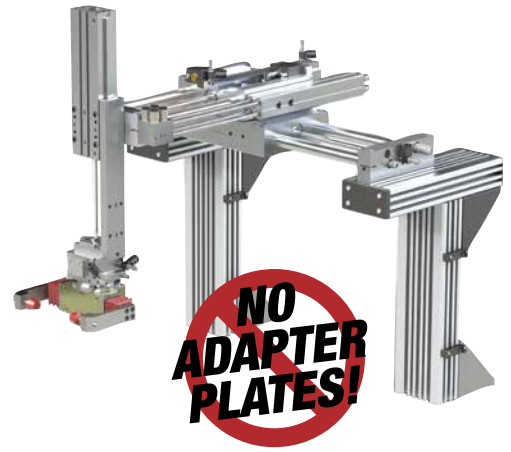

Modular DIRECTCONNECT Mounting Style Examples:

Look for more examples of each main section of the catalog. This is a sample of configurations we offer. Custom solutions also available.

Grip & Rotate

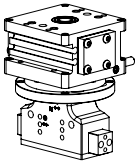

DRF Rotary Actuator to DPDL Parallel Gripper

Pick & Rotate

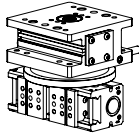

DRF Rotary Actuator to DPP Parallel Gripper

Place & Rotate

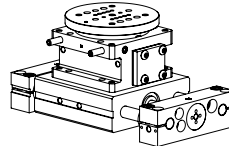

DLB Base Slide to DRF Rotary Actuator

Place & Rotate

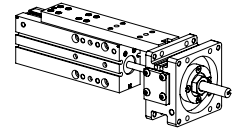

DLM Linear Slide to DRG Rotary Actuator

Rotate & Place

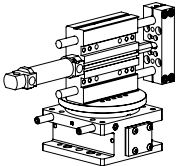

DRF Rotary Actuator to DLT Linear Slide

Pick & Place

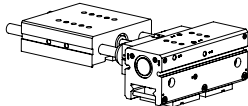

DLT Base Slide to DPP Parallel Gripper

Place & Place

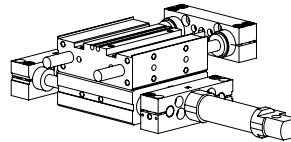

DLB Base Slide to DLT Linear Slide

Place & Place

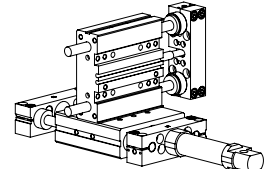

DLB Base Slide to DLT Linear Slide

Connect Different Sizes & Styles

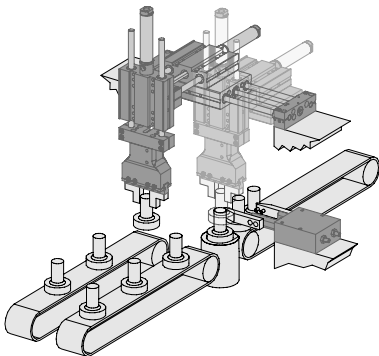

Configure in Multiple Orientations

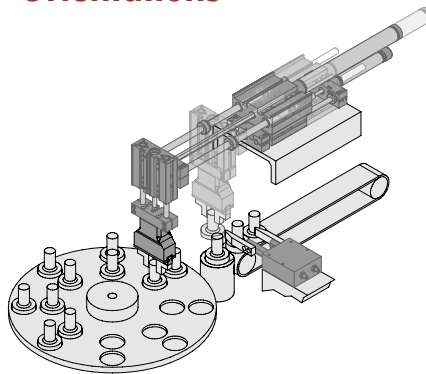

Look for the DIRECTCONNECT Logo

Product Series beginning with the letter D have a DIRECTCONNECT option, with a few exceptions.

DIRECTCONNECT

HOW TO MAKE A DIRECTCONNECT™ MOUNT

The DIRECTCONNECT Modular Compatibility Chart (on the next page) shows all the products that can easily connect together without adapter plates. Simply locate your first product along the horizontal axis of the top of chart, then locate the second product along the vertical axis on the left side of the chart. If a connection can be made, a mounting pattern will be shown.

DIRECTCONNECT Modular Compatibility Example:

Shown below, a DLB-10,12,16 Base Slide connecting to a DLT-10,12,16 Linear Thruster. Units may connect on different faces of the unit. Please refer to individual datasheets for DIRECTCONNECT mounting surfaces.

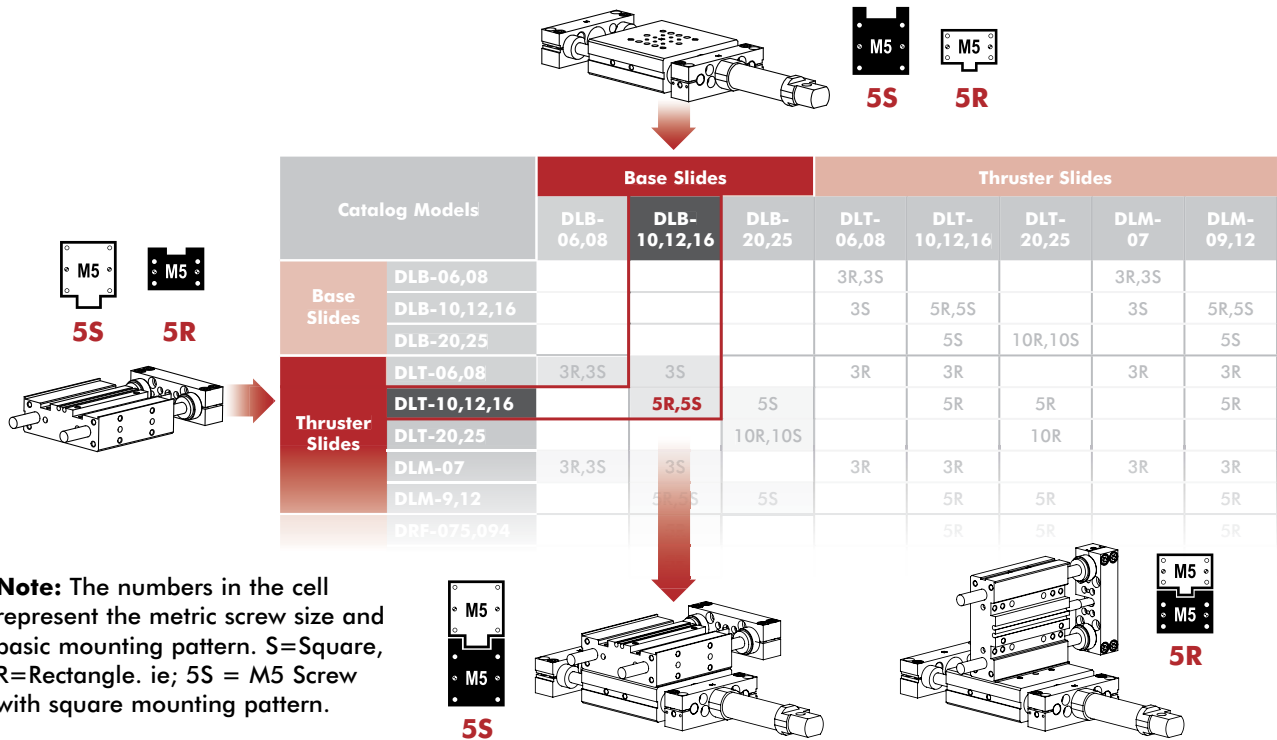

DirectConnect Mounting Surface Example:

Locate matching DIRECTCONNECT mounting pattern icons on the products dimensional drawings to determine what surface faces can be connected to. Corresponding mates equal a DIRECTCONNECT connection.

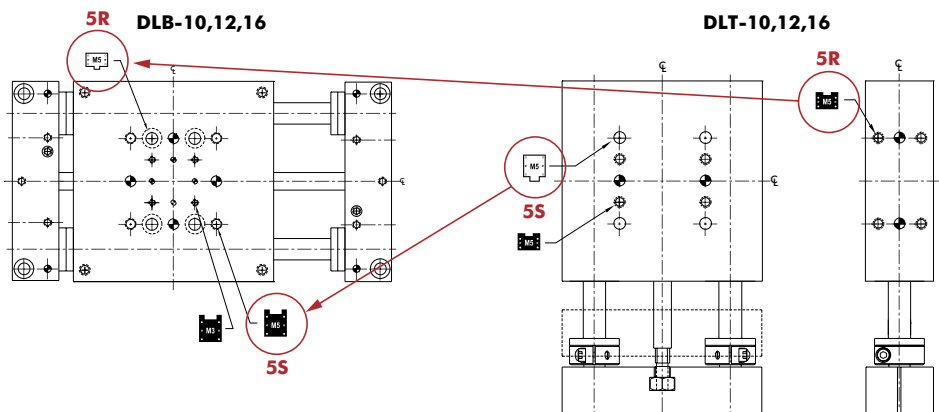

DIRECTCONNECT™ MODULAR COMPATIBILITY CHART

DESTACO's modular automation systems feature DirectConnect™ technology, allowing all components of the system—base slides, block thrusters, thruster slides, grippers, and rotaries—to be mounted together quickly & easily without any adapter plates. Look for matching icons on product datasheets for mounting compatibility.

Simply locate your first product along the horizontal axis of the top of chart, then locate the second product along the vertical axis on the left side of the chart. If a connection can be made, a mounting pattern will be shown.

Note: The numbers in the cell represent the metric screw size and basic mounting pattern. S=Square, R=Rectangle. ie; 5S = M5 Screw with square mounting pattern.



M5 (S)quare M5 (R)ectangle

Catalog Models		Base Slides		
		DLB-06&08	DLB-10,12&16	DLB-20&25
Base Slides	DLB-06 & 08			
	DLB-10, 12 & 16			
	DLB-20 & 25			
Thruster Slides	DLT-06 & 08	3R,3S	3S	
	DLT-10, 12 & 16		5R,5S	5S
	DLT-20 & 25			10R,10S
	DLM-07	3R,3S	3S	
	DLM-9 & 12		5R,5S	5S
Rotary Actuators	DRF-075 & 094		5R	
	DRF-106		5R	10R
	DRF-131		5R	10R
	DRG-074 & 094		5R	
	DRG-106		5R	10R
	DRG-131		5R	10R
Grippers	DGC		5R	
	DPG		5R	
	DCT-12, 16 & 25	3R		
	DCT-25		5R	
	DPDL-047 & 056	3R		
	DPDL-088 & 125		5R	
	DPDL-175 & 250			10R
	DPDS-047 & 056	3R		
	DPDS-088 & 125		5R	
	DPDS-175 & 250			10R
	DPL-25xx		5R	
	DPL-32xx & 40xx			10R
	DPP-10 & 14	3R		
	DPP-20		5R	
	DPP-28		5R	10R
	DPW-250	3R		
	DPW-375 & 500		5R	
	G100-08 & 011	3R		
	G100-18 & 25		5R	
	DPE-200		5R	
DPE-400			10R	

DIRECTCONNECT™ MODULAR COMPATIBILITY CHART

Thruster Slides					Rotary Actuators		
DLT-06&08	DLT-10,12&16	DLT-20&25	DLM-07	DLM-09&12	DRF-075&094	DRF-106	DRF-131
3R,3S			3R,3S				
3S	5R,5S		3S	5R,5S	5R	5R	5R
	5S	10R,10S		5S		10R	10R
3R	3R		3R	3R	3R,3S	3R,3S	
	5R	5R		5R	5R,5S	5R,5S	5R,5S
		10R					10R,10S
3R	3R		3R	3R	3R,3S	3R,3S	
	5R	5R		5R	5R,5S	5R,5S	5R,5S
	5R	5R		5R	5R	5R	5R
	5R	10R		5R	5R	5R	10R
	5R	10R		5R	5R	5R	10R
	5R	5R		5R	5R	5R	5R
	5R	10R		5R	5R	5R	10R
	5R	10R		5R	5R	5R	10R
	5R	5R		5R	5R	5R	5R
	5R	5R		5R	5R	5R	5R
3R	3R		3R	3R	3R	3R	
	5R	5R		5R	5R	5R	5R
3R	3R		3R	3R	3R	3R	
	5R	5R		5R	5R	5R	5R
		10R					10R
3R	3R		3R	3R	3R	3R	
	5R	5R		5R	5R	5R	5R
		10R					10R
	5R	5R		5R	5R	5R	5R
		10R					10R
3R	3R		3R	3R	3R	3R	
	5R	5R		5R	5R	5R	5R
	5R	10R		5R	5R	5R	10R
3R	3R		3R	3R	3R	3R	
	5R	5R		5R	5R	5R	5R
3R	3R		3R	3R	3R	3R	
	5R	5R		5R	5R	5R	5R
	5R	5R		5R	5R	5R	5R
		10R					10R

Accessories

Sensor Accessories	Model Numbers	Part Number	Qty/Unit
Sensor, NPN magneto resistive type, 4mm Barrel	All Models	OHSN-021	1-4
Sensor, PNP magneto resistive type, 4mm Barrel	All Models	OHSP-021	1-4
Cable straight, quick disconnect, socket, 3 conductor, 2M length	All Models	CABL-010	1-4

*Sensor and cable sold separately.

Power, Seal and Finger Mounting Accessories	08M	11M	18M	25M	Qty/Unit
Pneumatic air fitting	PLFT-021		PLFT-041		2
Valve kit, failsafe	N/A		OFSV-004		1
Jaw locating sleeve for precise finger mounting	20961-11		20962-11	20963-11	4
Seal Kit (includes): End gasket (Qty 2) Seal: U-cup Buna replacement seal (Qty 4) Button head socket cap screws (Qty 8)	SLKT-244	SLKT-245	SLKT-246	SLKT-247	1

Commissioning Kits for Easy Ordering



2 Sensors



2 Air Fittings



4 Jaw Locating Finger Sleeves



4 Finger Mounting Screws

Commissioning Kits for:	Part Number
G110-08M, G120-08M	G110-QKST-101
G110-11M, G120-11M	G110-QKST-102
G110-18M, G120-18M	G110-QKST-103
G110-25M, G120-25M	G110-QKST-104

G120 Extended Jaw Option, Finger Interchangeability Table*

(G120 units ship with extended jaw option installed)



Extended Jaw Option Part Number	Mounts to G110 Series Part Number	Compatible with SMC Part Number
G110-FNGR-08M-05	G110-08M-05-N-B	MHZ2-10
G110-FNGR-08M-10	G110-08M-10-N-B	MHZL2-10
G110-FNGR-11M-05	G110-11M-05-N-B	MHZ2-16
G110-FNGR-11M-10	G110-11M-10-N-B	MHZL2-16
G110-FNGR-18M-12	G110-18M-12-N-B	MHZ2-25
G110-FNGR-18M-24	G110-18M-24-N-B	MHZL2-25
G110-FNGR-25M-20	G110-25M-20-N-B	MHZ2-32

*Verify acceptable stroke and force changes in the table above for your application. G120 units are shipped with the extended jaw option mounted from factory. SMC is a registered trademark of SMC Corporation.

T100 SERIES

OEM Linear Slide

How To Order

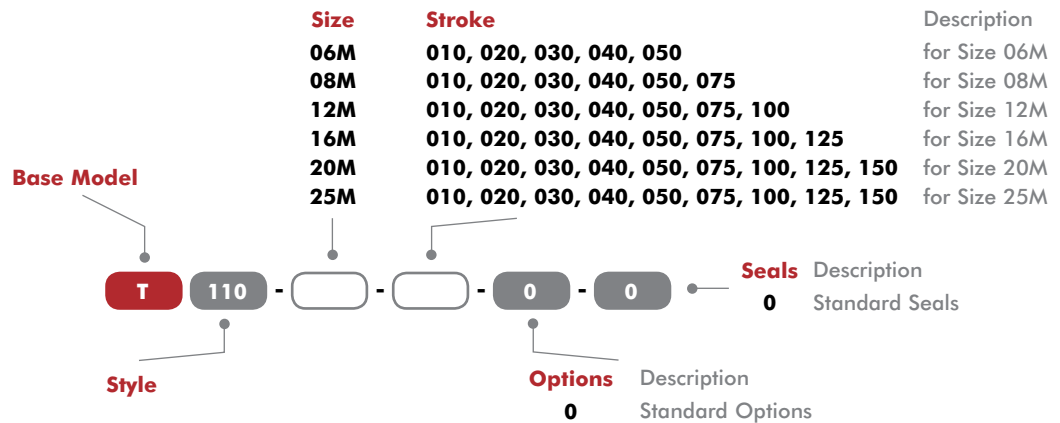

Size	Thrust Force at 7 bar [100 psi]	Stroke Availability								
		10mm	20mm	30mm	40mm	50mm	075mm	100mm	125mm	150mm
06M	29N [7 lbf]	•	•	•	•	•				
08M	53N [12 lbf]	•	•	•	•	•	•			
12M	119N [27 lbf]	•	•	•	•	•	•	•		
16M	211N [47 lbf]	•	•	•	•	•	•	•	•	
20M	330N [74 lbf]	•	•	•	•	•	•	•	•	•
25M	529N [119 lbf]	•	•	•	•	•	•	•	•	•

Accessories

Sensor Accessories	Model Numbers	Part Number	Qty/Unit
Sensor, NPN magneto resistive type, 4mm Barrel	All Models	OHSN-021	1-2
Sensor, PNP magneto resistive type, 4mm Barrel	All Models	OHSP-021	1-2
Cable straight, quick disconnect, socket, 3 conductor, 2M length	All Models	CABL-010	1-2

*Sensor and cable sold separately.

Power, Stop, Shock & Seals Accessories	06M	08M	12M	16M	20M	25M	Qty/Unit
Adjustable Flow Control, 6mm OD Tube	VLVF-008			VLVF-005			1-2
Stop Adjuster Kit, Extend	OSAK-088	OSAK-089	OSAK-090	OSAK-091	OSAK-092	OSAK-093	1
Stop Adjuster Kit, Retract	OSAK-094	OSAK-095	OSAK-096	OSAK-097	OSAK-098	OSAK-099	1
Shock Absorber Kit, Extend	N/A	OSAK-123	OSAK-124	OSAK-125	OSAK-126	OSAK-127	1
Shock Absorber Kit, Retract		OSAK-128	OSAK-129	OSAK-130	OSAK-131	OSAK-132	1
Spare Shock Absorber		SHOK-057	SHOK-057	SHOK-059	SHOK-060	SHOK-061	1
Seal Repair Kit (includes: Piston Seal, Retainer C-clip, Rod Seal, O-ring, Bumper)	SLKT-248	SLKT-249	SLKT-250	SLKT-251	SLKT-252	SLKT-253	1

Commissioning Kits for Easy Ordering



2 Sensors



2 Cables



2 Adjustable Flow Controls



1 Shock Kit, Retract

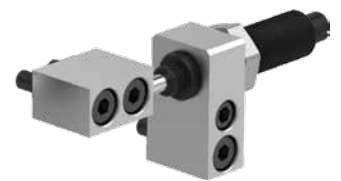

1 Shock Kit, Extend

Commissioning Kits for:	Part Number
T110-06M	T110-QKST-101
T110-08M	T110-QKST-102
T110-12M	T110-QKST-103
T110-16M	T110-QKST-104
T110-20M	T110-QKST-105
T110-25M	T110-QKST-106

DPE-400 HEAVY-DUTY

Electric Parallel Grippers

How To Order

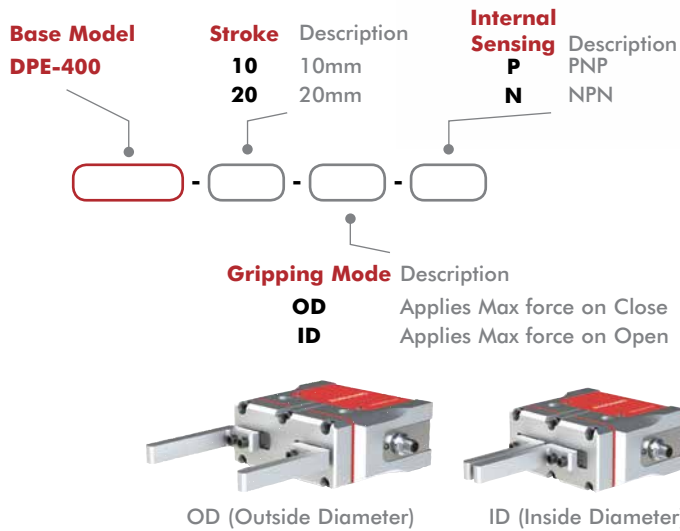
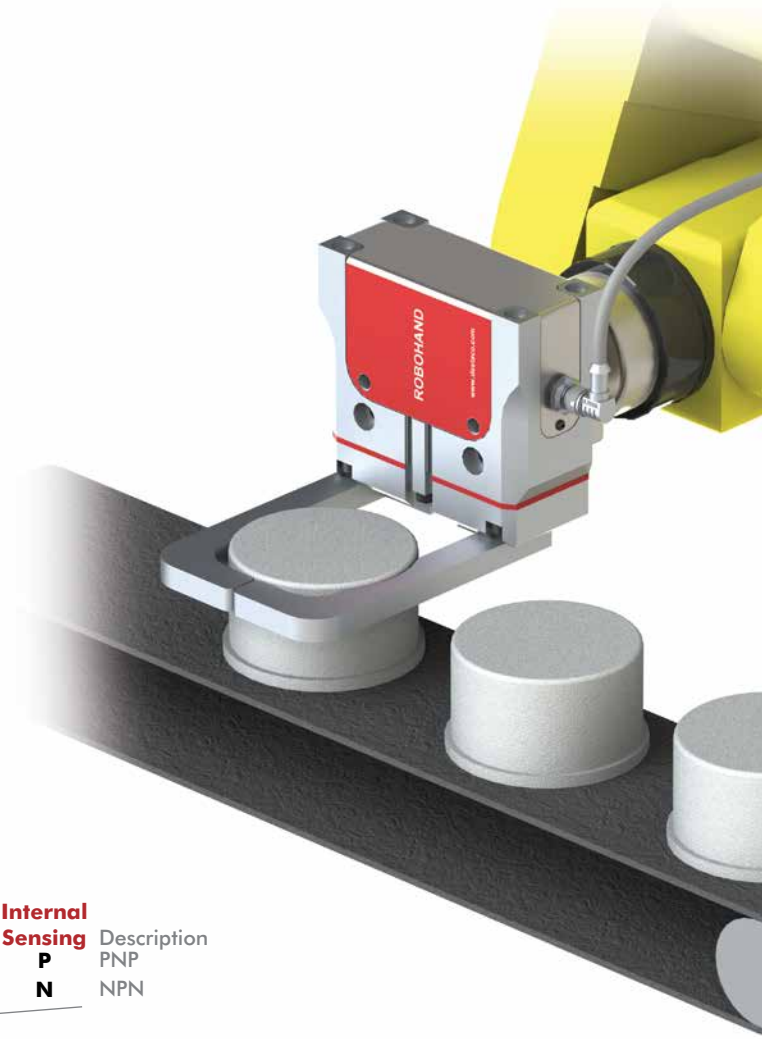

Size	Total Rated Grip Force N [lbs]	Total Stroke
DPE-400-10	667-1334 [150-300]	10 [0.39]
DPE-400-20	445-890 [100-200]	20 [0.78]

Accessories

Power and Sensor Accessories	Part Number
PNP Magneto-Resistive Position Sensor	OHSP-017
NPN Magneto-Resistive Position Sensor	OHSN-017
Quick Disconnect Sensor Cable, 5m long	CABL-013
8-wire Power and Signal Cable, 5m long with Straight M12 Connector	CABL-052
8-wire Power and Signal Cable, 5m long with 90° M12 Connector	CABL-053

* Sensor and cable sold separately.

DPE-200 MEDIUM-DUTY

Electric Parallel Grippers

How To Order

Base Model
DPE-200

Stroke
25

Description
25mm

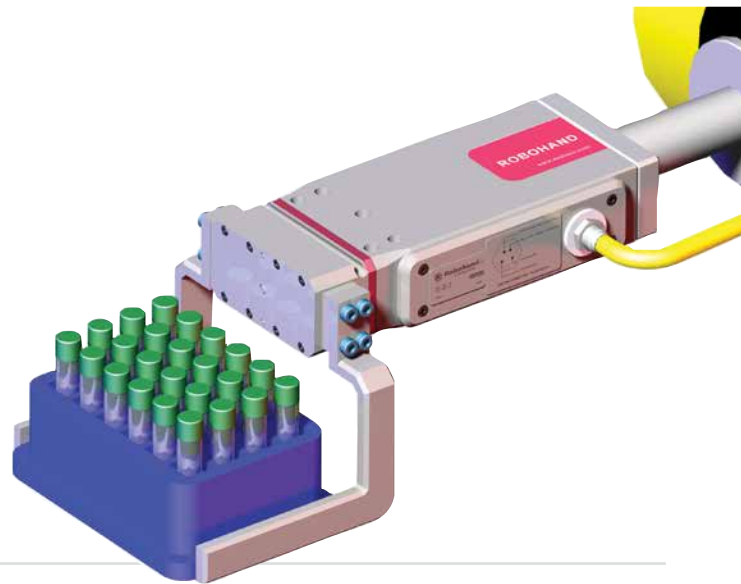
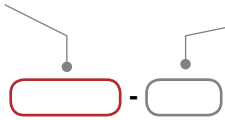

Size	Total Rated Grip Force N [lbs]	Total Stroke
DPE-200-25	111 [25]	25 [0.98]

Accessories

Power and Sensor Accessories	Part Number
PNP Magneto-Resistive Position Sensor	OHSP-017
NPN Magneto-Resistive Position Sensor	OHSN-017
Quick Disconnect Sensor Cable, 5m Long	CABL-013
4-wire Power and Signal Cable, 5m Long	CABL-046

*Sensor and cable sold separately.

How To Order

Base Model
RPE

Gripping Orientation
100M Perpendicular to Connector
101M In-line to Connector

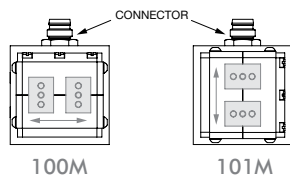

Size	Total Rated Grip Force N [lbs]	Total Stroke
RPE-100M/101M	5 [1.1]	4 [0.16]

Accessories

Sensor Accessories	Part Number
Inductive Sensor Mounting Kit (Mounts 1 sensor)	OSMK-130
PNP Inductive Sensor with Quick Connect	OISP-019
NPN Inductive Sensor with Quick Connect	OISN-019
Quick Disconnect Sensor Cable, 2m long	CABL-010
Quick Disconnect Sensor Cable, 5m long	CABL-013

*Sensor and cable sold separately.

2P SERIES

2-Jaw Precision Parallel Grippers

How To Order



Note: See catalog for complete options information.

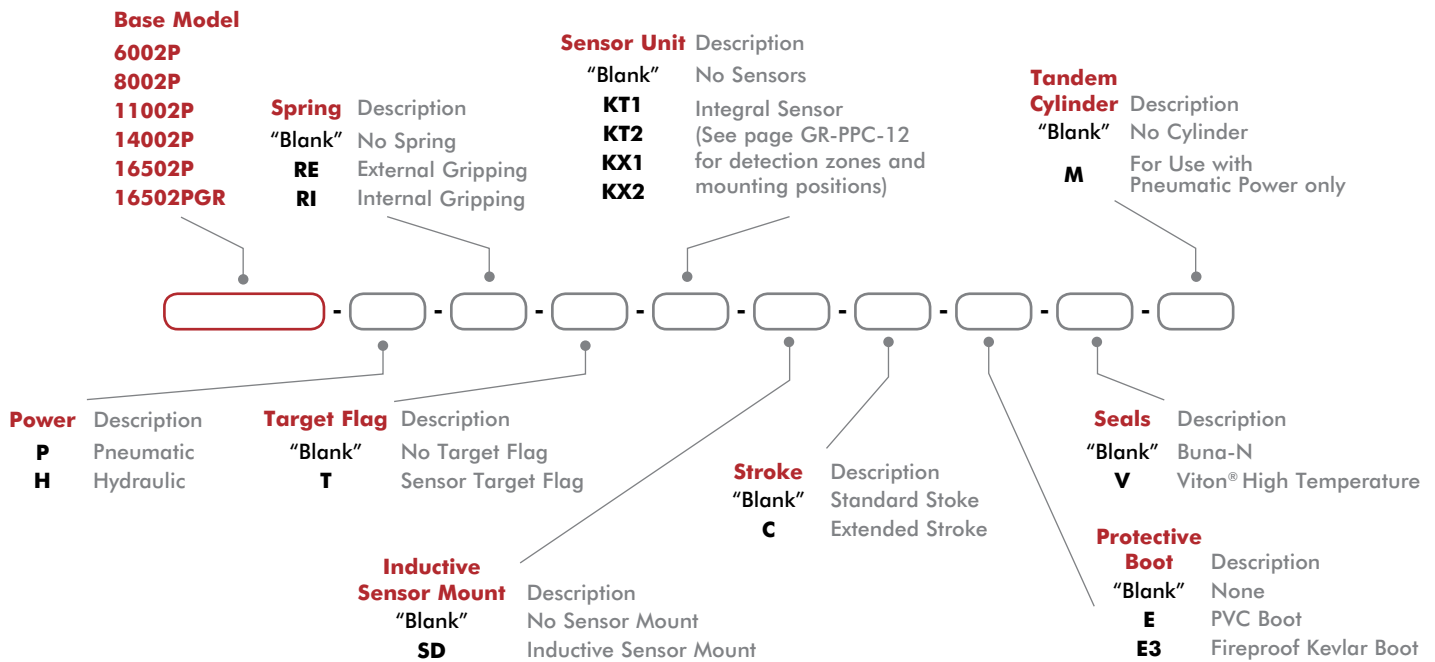

Size	Grip Force (F6+R) 1, 6 bar [87 psi], Springs Mid-Way, L=0 N [lbs]	Grip Force (F0+R) 2, 0 bars, Springs Mid-Way, L=0 N [lbs]	Total Stroke mm [in]
-6002P-P	694 [156]	176 [40]	10 [0.39]
-6002P-P-C	432 [97]	109 [24]	16 [0.63]
-8002P-P	1946 [437]	635 [143]	13 [0.51]
-8002P-P-C	1256 [282]	410 [92]	20 [0.79]
-11002P-P	3043 [684]	965 [217]	20 [0.79]
-11002P-P-C	2030 [456]	644 [145]	30 [1.18]

Size	Grip Force (F6+R) 1, 6 bar [87 psi], Springs Mid-Way, L=0 N [lbs]	Grip Force (F0+R) 2, 0 bars, Springs Mid-Way, L=0 N [lbs]	Total Stroke mm [in]
-14002P-P	6232 [1400]	2305 [518]	26 [1.02]
-14002P-P-C	4031 [906]	1490 [335]	40 [1.57]
-16502P-P	11475 [2579]	3825 [860]	30 [1.18]
-16502P-P-C	6878 [1546]	2292 [515]	50 [1.97]
1650PGR-P	11475 [2579]	3825 [860]	30 [0.39]

2P SERIES

2-Jaw Precision Parallel Grippers

Size	Seal Repair Kits			Protective Boots	
	Buna-N	Viton®	Hydraulic	PVC - Brown or Black	Fireproof KEVLAR - Red
-6002P	SLKT-156	SLKT-156V	SLKT-330	ER62P	E3R62P
-8002P	S80	S80V	S80H	ER82P	E3R82P
-11002P	S100	S110V	S110H	ER112P	E3R112P
-14002P	SLKT-333	SLKT-333	SLKT-334	KP-311	KP-313
-16502P				KP-314	KP-316
16502PGR	SLKT-335	SLKT-335V	SLKT-336	N/A	KENVE2-21384

Accessories

Sensor Accessories	Model Numbers	Part Number	Qty/Unit
M8 Inductive Sensor PNP with M8 Connector	6002P, 8002P, 11002P	OISP-011-C	1-4
M8 Inductive Sensor NPN with M8 Connector	6002P, 8002P, 11002P	OISN-011-C	1-4
M8 Inductive Sensor PNP with M12 Connector	14002P, 16502P	OISP-017-C	1-4
M8 Inductive Sensor NPN with M12 Connector	14002P, 16502P	OISN-017-C	1-4
M8 Quick Disconnect 2 Meter Cable Length*	6002P, 8002P, 11002P	CABL-010	1-4
M12 Quick Disconnect 2 Meter Cable Length*	14002P, 16502P	CABL-014	1-4
Inductive Sensor Kit (1 holder + 1 flag)	6002P, 8002P	SD60-80P	1-2
Inductive Sensor Kit (1 holder + 1 flag)	11002P	SD110P	1-2
Inductive Sensor Kit (1 holder + 1 flag)	14002P	OSMK-114	1-2
Inductive Sensor Kit (1 holder + 1 flag)	16502P	OSMK-115	1-2

* Sensor and cable sold separately.

DGC/GC SERIES

2-Jaw Precision Parallel Grippers

How To Order

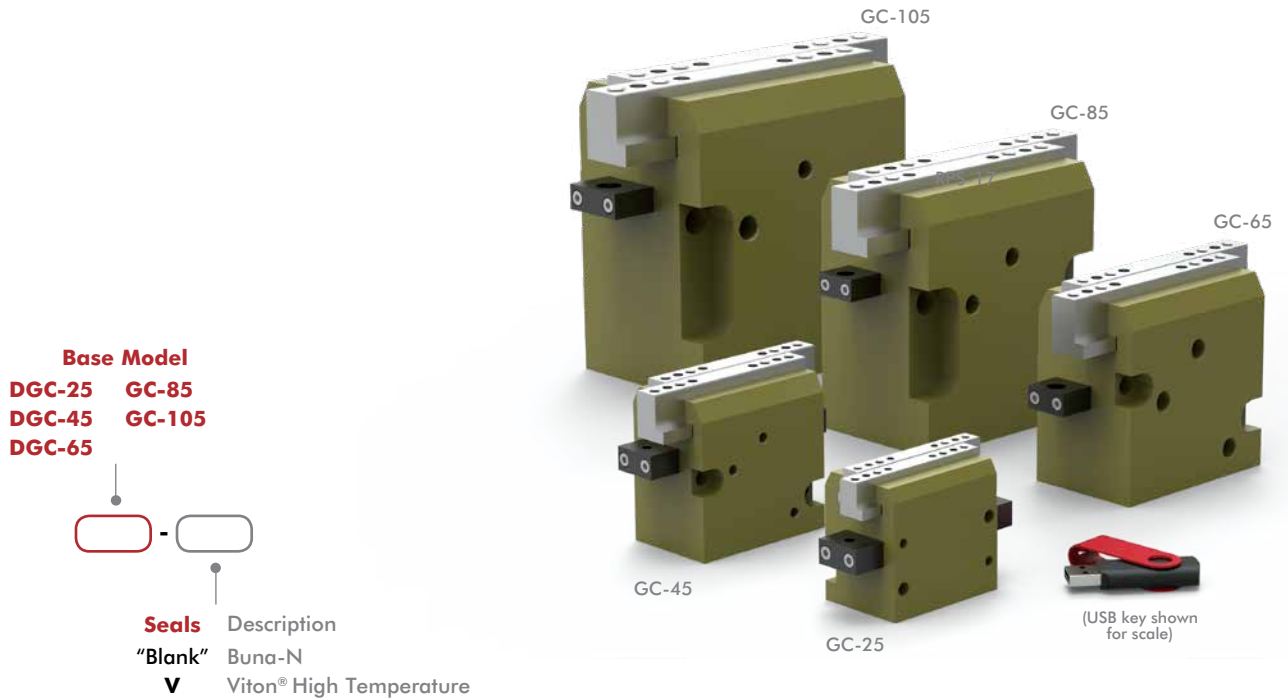

Size	Total Rated Grip Force @100 psi [7 bar] N [lbs]	Total Stroke mm [in]
-25	474 [106]	20 [0.787]
-45	481 [108]	30 [1.181]
-65	796 [179]	40 [1.575]
-85	1480 [333]	50 [1.968]
-105	2318 [521]	60 [2.362]

Size	Seal Repair Kits	
	Buna-N	Viton®
-25	SLKT-319	SLKT-319V
-45	SLKT-321	SLKT-321V
-65	SLKT-323	SLKT-323V
-85	SLKT-325	SLKT-325V
-105	SLKT-327	SLKT-327V

Accessories

Sensor Accessories	Model Numbers	Part Number	Qty/Unit
4mm NPN Inductive Sensor with Quick Disconnect*	25, 45	OHSN-014	1-2
4mm PNP Inductive Sensor with Quick Disconnect*	25, 45	OHSP-014	1-2
8mm NPN Inductive Sensor with Quick Disconnect*	65, 85	OHSN-011	1-2
8mm PNP Inductive Sensor with Quick Disconnect*	65, 85	OHSP-011	1-2
12mm NPN Inductive Sensor with Quick Disconnect*	105	OHSN-017	1-2
12mm PNP Inductive Sensor with Quick Disconnect*	105	OHSP-017	1-2
Quick Disconnect 2 Meter Cable Length*	24, 45, 65, 85	CABL-010	1-2
Quick Disconnect 5 Meter Cable Length*	24, 45, 65, 85	CABL-013	1-2
Quick Disconnect 2 Meter Cable Length*	105	CABL-014	1-2
Quick Disconnect 5 Meter Cable Length*	105	CABL-018	1-2

* Sensor and cable sold separately.

How To Order

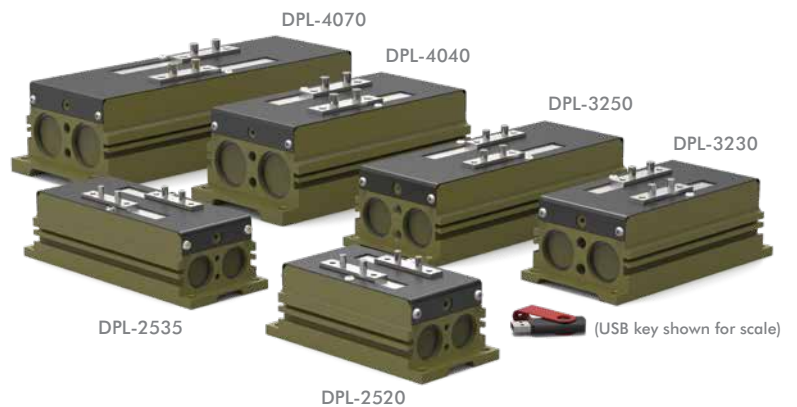
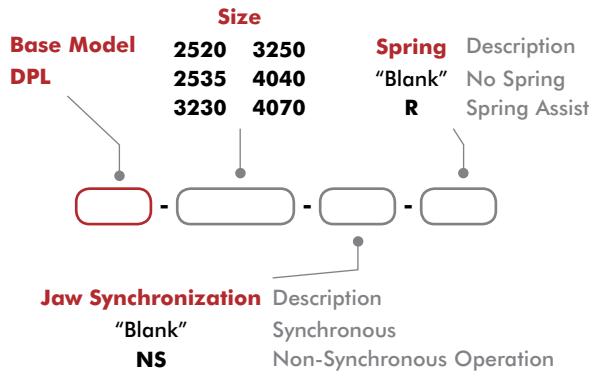

Size	Total Rated Grip Force @100 psi [7 bar] N [lbs]	Total Stroke mm [in]	Size	Seal Repair Kit Buna-N	Rear Inlet Seal Repair Kit	In-line Jaw Mounting Kit	Inductive Sensor Mtg Kit (3 Holder/2 Flags)
-2520	811 [182]	40 [1.57]	-2520			ODPL-001	OSMK-099
-2535	768 [173]	70 [2.76]	-2535	SLKT-233		ODPL-002	
-3230	1359 [306]	60 [2.36]	-3230			ODPL-003	OSMK-100
-3250	1306 [294]	100 [3.94]	-3250	SLKT-234	SLKT-316	ODPL-004	
-4040	2035 [457]	80 [3.15]	-4040			ODPL-005	OSMK-101
-4070	2029 [456]	140 [5.51]	-4070	SLKT-235		ODPL-006	

Accessories

Sensor Accessories	Model Numbers	Part Number	Qty/Unit
M8 PNP Magneto Resistive Sensor with Quick Disconnect*	All Models	OHSP-017	1-3
M8 NPN Magneto Resistive Sensor with Quick Disconnect*	All Models	OHSN-017	1-3
M8 PNP Magneto Resistive Sensor (90° barrel) w/Qk. Disc.*	All Models	OHSP-011	1-3
M8 NPN Magneto Resistive Sensor (90° barrel) w/Qk. Disc.*	All Models	OHSN-011	1-3
M8 PNP Inductive Sensor with Quick Disconnect*	2520, 2535, 3230, 3250	OISP-011	1-3
M8 NPN Inductive Sensor with Quick Disconnect*	2520, 2535, 3230, 3250	OISN-011	1-3
M12 PNP Inductive Sensor with Quick Disconnect*	4040, 4070	OISP-017	1-3
M12 NPN Inductive Sensor with Quick Disconnect*	4040, 4070	OISN-017	1-3
Inductive Sensor Mounting Kit (3 Holders + 2 Flags)	See Datasheet		1
M8 Quick Disconnect 2 Meter Cable Length*	All Models	CABL-010	1-3
M8 Quick Disconnect 5 Meter Cable Length*	All Models	CABL-013	1-3
M12 Quick Disconnect 2 Meter Cable Length*	4040, 4070	CABL-014	1-3
M12 Quick Disconnect 5 Meter Cable Length*	4040, 4070	CABL-018	1-3

Pneumatic Accessories	Model Numbers	Part Number	Qty/Unit
Fitting Push-in Straight M5 - 6mm O.D. Tube	2520, 2535	PLFT-037	1-2
Fitting Push-in 90° Elbow M5 - 6mm O.D. Tube	2520, 2535	PLFT-041	1-2
Fitting Push-in Straight G1/8 - 6mm O.D. Tube	3230, 3250, 4040, 4070	PLFT-038	1-2
Fitting Push-in 90° Elbow G1/8 - 6mm O.D. Tube	3230, 3250, 4040, 4070	PLFT-042	1-2

* Sensor and cable sold separately.

DPP SERIES

2-Jaw Precision Parallel Grippers

How To Order

Base Model
DPP

Size
10M-06 20M-25
10M-12 20M-38
14M-15 28M-31
14M-25 28M-50

Spring
"Blank" No Spring
C Spring Closed

Jaw Synchronization
"Blank" Synchronous
NS Non-Synchronous Operation

Seals
"Blank" Buna-N
V Viton® High Temperature

U.S. Patent #4,874,194
(USB key shown for scale)

Size	Total Rated Grip Force @100 psi [7 bar] N [lbs]	Total Stroke mm [in]
-10M-6	120 [27]	6.4 [0.25]
-10M-12		12.7 [0.50]
-14M-15	227 [51]	15.9 [0.63]
-14M-25	214 [48]	25.4 [1.00]
-20M-25	458 [103]	
-20M-38	449 [101]	38.1 [1.50]
-28M-31	912 [205]	
-28M-50	934 [210]	

*With springs

Size	Seal Repair Kits		
	Buna-N	Viton®	Manifold (Viton®)
-10M	SLKT-343	SLKT-343V	SLKT-241V
-14M	SLKT-344	SLKT-344V	
-20M	SLKT-345	SLKT-345V	SLKT-242V
-28M	SLKT-346	SLKT-346V	SLKT-243V

Accessories

Sensor Accessories	Model Numbers	Part Number	Qty/Unit
Inductive Sensor Mounting Kit (Mounts 2 sensors)	10M, 14M	OSMK-119	1-2
Inductive Sensor Mounting Kit (Mounts 2 sensors)	20M, 28M	OSMK-120	1-2
NPN Inductive Sensor (with Qk. Disc.)*	All Models	OISN-014	1-4
PNP Inductive Sensor (with Qk. Disc.)*	All Models	OISP-014	1-4
NPN Magneto Resistive Sensor (with Qk. Disc.)*†	All Models	OHSN-017	1-4
PNP Magneto Resistive Sensor (with Qk. Disc.)*†	All Models	OHSP-017	1-4
NPN Magneto Resistive Sensor 90° (with Qk. Disc.)*†	All Models	OHSN-011	1-4
PNP Magneto Resistive Sensor 90° (with Qk. Disc.)*†	All Models	OHSP-011	1-4
Quick Disconnect Cable (2 meters long)*	All Models	CABL-010	1-4
Quick Disconnect Cable (5 meters long)*	All Models	CABL-013	1-4

Pneumatic Accessories	Model Numbers	Part Number	Qty/Unit
Adjustable Flow Control-M3 Elbow-3MM OD Tube Push-in Style	10M, 14M	VLVF-018	1-2
Adjustable Flow Control-M5 Elbow-6MM OD Tube Push-in Style	20M, 28M	VLVF-008	1-2
Fail Safe Valve - M5	All Models	OFSV-004	1

* Sensor and cable sold separately. †Piston magnet standard.

RP-P SERIES

2-Jaw Precision Parallel Grippers

How To Order

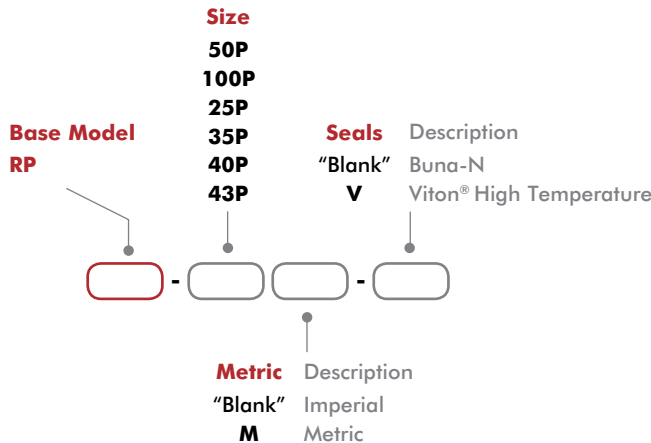

Size	Total Rated Grip Force @100 psi [7 bar]* N [lbs]	Total Stroke mm [in]
-50P	107 [24]	12.7 [0.50]
-100P	160 [36]	25.4 [1.00]
-25P	356 [80]	28.7 [1.13]
-35P	778 [175]	25.4 [1.00]
-40P	890 [200]	50.8 [2.00]
-43P	2224 [500]	76.2 [3.00]

Size	Seal Repair Kits		Inductive Sensor Mtg Kit (mounts 2 sensors)
	Buna-N	Viton®	
-50P	SLKT-353	SLKT-353V	OSMK-003
-100P	SLKT-037	SLKT-037V	OSMK-004
-25P	SLKT-046	SLKT-046V	OSMK-023
-35P	SLKT-049	SLKT-049V	OSMK-023
-40P	SLKT-050	SLKT-050V	OSMK-033
-43P	SLKT-051	SLKT-051V	OSMK-033

Accessories

Sensor Accessories	Model Numbers	Part Number	Qty/Unit
3mm NPN Inductive Sensor with Quick Disconnect*	RP-50P	OISN-019	1-2
3mm PNP Inductive Sensor with Quick Disconnect*	RP-50P	OISP-019	1-2
3mm NPN Inductive Sensor with Quick Disconnect*	RP-100P, -25P, RP-50P, -110P, -25P	OISN-014	1-2
3mm PNP Inductive Sensor with Quick Disconnect*	RP-100P, -25P, RP-50P, -110P, -25P	OISP-014	1-2
Inductive Sensor Mounting Kit for (mounts 2 sensors)	See Datasheet		1
Quick Disconnect 2 Meter Cable Length*	All Models	CABL-010	1-2
Quick Disconnect 5 Meter Cable Length*	All Models	CABL-013	1-2

Pneumatic Accessories	Model Numbers	Part Number	Qty/Unit
Fail Safe Valve (Imperial)	RP-50P, -110P, -25P	OFSV-001	1
Fail Safe Valve (Metric)	RP-50P, -110P, -25P	OFSV-004	1
Fail Safe Valve (Imperial)	RP-35P, -40P, -43P	OFSV-002	1
Fail Safe Valve (Metric)	RP-50P, -110P, -25P	OFSV-005	1
Stroke Limited Opening Valve (LTD)	RP-35P, -40P, -43P	OLDT-001	1
Stroke Limited Opening Valve (LTD)	RP-50P, -110P, -25P	OLDT-002	1

* Sensor and cable sold separately.

RPL/RPLC SERIES

2-Jaw Precision Parallel Grippers

How To Order

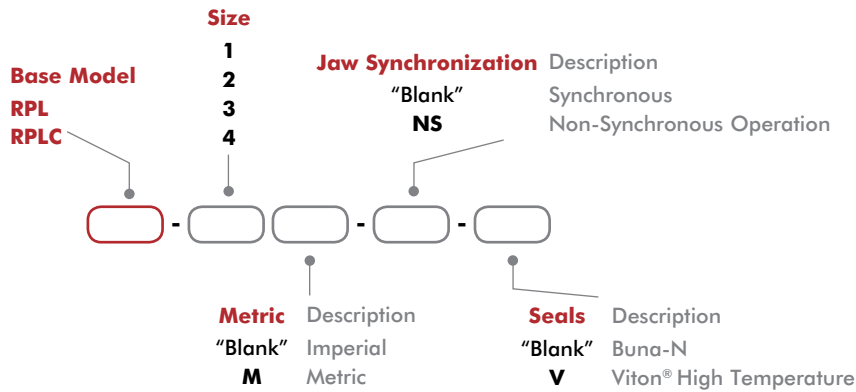
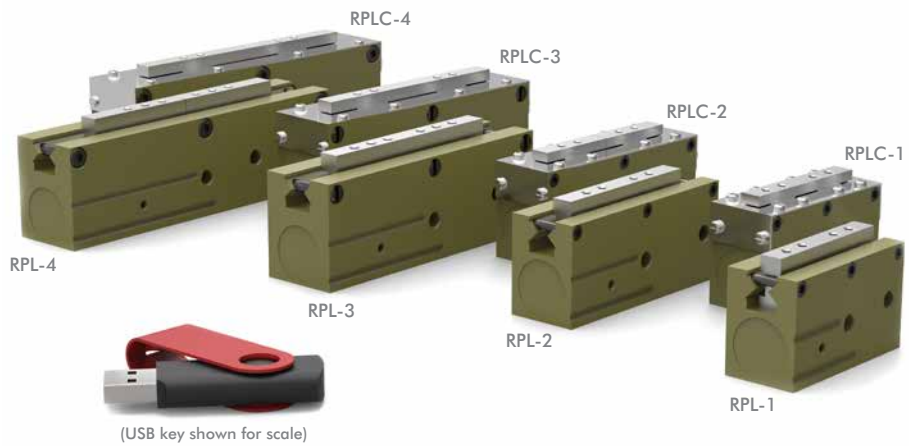

Size	Total Rated Grip Force @100 psi [7 bar] N [lbs]	Total Stroke mm [in]	Seal Repair Kits	
			Buna-N	Viton®
-1	116 [26]	6.4 [0.25]	SLKT-010	SLKT-010V
-2		12.7 [0.50]		
-3	160 [36]	19.1 [0.75]	SLKT-012	SLKT-012V
-4		25.4 [1.00]		

Accessories

Sensor Accessories	Model Numbers	Part Number	Qty/Unit
Sensor Mounting Kit for Imperial & Metric Units (mounts 2 sensors)	All Models	OSMK-008	1
NPN Magneto Resistive Sensor with Quick Disconnect*	All Models	OHSN-017	1-2
PNP Magneto Resistive Sensor with Quick Disconnect*	All Models	OHSP-017	1-2
Quick Disconnect 2 Meter Cable Length*	All Models	CABL-010	1-2
Quick Disconnect 5 Meter Cable Length*	All Models	CABL-013	1-2

Pneumatic Accessories	Model Numbers	Part Number	Qty/Unit
Fail Safe Valve (Imperial)	All Models	OFSV-001	1
Fail Safe Valve (Metric)	All Models	OFSV-004	1

* Sensor and cable sold separately.

CP SERIES

2-Jaw General Industrial Grippers

How To Order

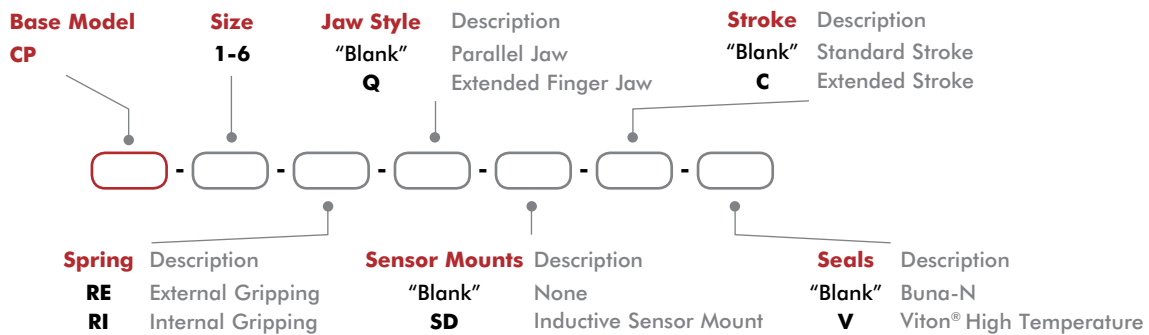
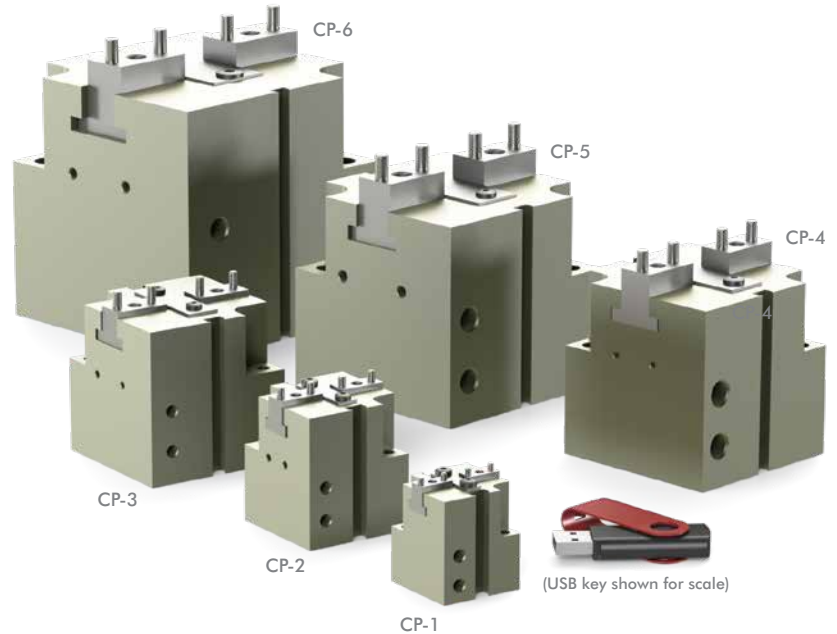

Size	Total Rated Grip Force F @ 100 psi [7 bar] w/o Spring Assist	Total Rated Grip Force F @ 100 psi [7 bar] with Spring Assist	Total Stroke mm [in]
-1	89 [20]	15 [3]	4 [0.16]
-1-C	60 [13]	10 [2]	6 [0.24]
-2	238 [53]	43 [10]	6 [0.24]
-2-C	161 [36]	29 [7]	9 [0.35]
-3	677 [152]	161 [36]	10 [0.39]
-3-C	407 [91]	97 [22]	16 [0.63]

Size	Total Rated Grip Force F @ 100 psi [7 bar] w/o Spring Assist	Total Rated Grip Force F @ 100 psi [7 bar] with Spring Assist	Total Stroke mm [in]
-4	1016 [228]	222 [50]	13 [0.51]
-4-C	665 [149]	145 [33]	20 [0.79]
-5	1591 [358]	322 [72]	18 [0.71]
-5-C	1081 [243]	219 [49]	27 [1.06]
-6	2749 [618]	711 [160]	24 [0.94]
-6-C	2092 [470]	541 [122]	32 [1.26]

Size	Seal Repair Kits		Repair Kits (screws, springs, seals) -C		Inductive Sensor Mtg Kit (mounts 2 sensors) -SD
	Buna-N	Viton®	Buna-N	Viton®	
-1	SCP1	SCP1V	KSCP1	KSCP1V	N/A
-2	SCP2	SCP2V	KSCP2	KSCP2V	SDCP2
-3	SCP3	SCP3V	KSCP3	KSCP3V	SDCP3
-4	SCP4	SCP4V	KSCP4	KSCP4V	SDCP4
-5	SCP5	SCP5V	KSCP5	KSCP5V	SDCP5
-6	SCP1	SCP1V	KSCP1	KSCP1V	SDCP6

Accessories

Sensor Accessories	Model Numbers	Part Number	Qty/Unit
PNP Sensor with 0.3m Output Cable with 90° with M8 connector*	All Models	D1	1-2
NPN Sensor with 0.3m Output Cable with 90° with M8 connector*	CP-2, -3, -4, -5, -6	D10	1-2
PNP Sensor with 0.3m Output Cable with M8 connector*	All Models	D4	1-2
NPN Sensor with 0.3m Output Cable with M8 connector*	CP-2, -3, -4, -5, -6	D7	1-2
Inductive Sensor Mounting Kit (mounts 2 sensors) (SD)	See Datasheet		1
Inductive PNP Sensor with M8 Connector*	CP-2, -3, -4	OISP-011-C	1-2
Inductive NPN Sensor with M8 Connector*	CP-2, -3, -4	OISN-011-C	1-2
Inductive PNP Sensor with M12 Connector*	CP-5, -6	OISP-017-C	1-2
Inductive NPN Sensor with M12 Connector*	CP-5, -6	OISN-017-C	1-2
M8 Quick Disconnect 2 Meter Cable Length*	All Models	CABL-010	1-2
M12 Quick Disconnect 2 Meter Cable Length*	All Models	CABL-014	1-2

*Sensor and cable sold separately.

DPDL SERIES

2-Jaw General Industrial Grippers

How To Order

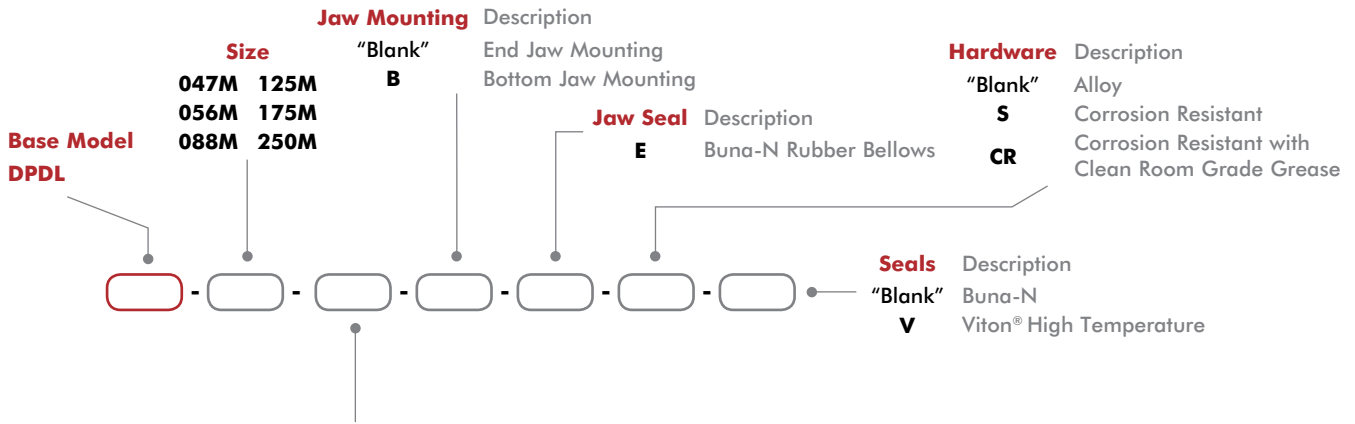
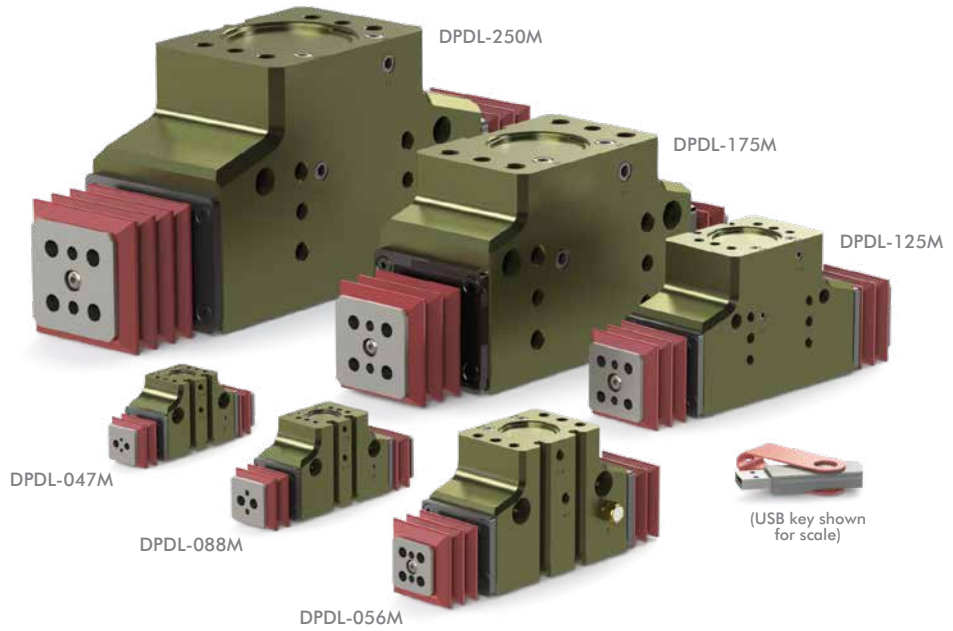

Stroke Stroke varies with size of gripper

047M	019, 025 or 038	125M	050, 075 or 100
056M	025, 038 or 050	175M	075, 100 or 150
088M	038, 050 or 075	250M	100, 150 or 200

Stroke dimensions

019	4.8mm [0.19]	050	12.7mm [0.50]	150	38.1mm [1.50]
025	6.4mm [0.25]	075	19.1mm [0.75]	200	50.8mm [2.00]
038	9.5mm [0.38]	100	25.4mm [1.00]		

Size	Total Rated Grip Force @100 psi [7 bar] N [lbs]	Total Stroke mm [in]
-047M	62 [14]	3.2 [0.13]
-056M	98 [22]	4.8 [0.19]
-088M	222 [50]	6.4 [0.25]
-125M	445 [100]	9.5 [0.38]
-175M	890 [200]	12.7 [0.50]
-250M	1779 [400]	19.1 [0.75]

Size	Seal Repair Kits			Sealed Jaw Boot Replacement (1 Buna-N Boot only)
	Buna-N	Viton®	Manifold (Viton®)	
-047M	SLKT-185	SLKT-185V		SLKT-191
-056M	SLKT-186	SLKT-186V	SLKT-197V	SLKT-192
-088M	SLKT-187	SLKT-187V	SLKT-199V	SLKT-193
-125M	SLKT-188	SLKT-188V		SLKT-194
-175M	SLKT-189	SLKT-189V	SLKT-201V	SLKT-195
-250M	SLKT-190	SLKT-190V		SLKT-196

Accessories

Sensor Accessories	Model Numbers	Part Number	Qty/Unit
PNP Magneto Resistive Sensor with Quick Disconnect*	047M, 056M, 088M, 125M	OHSP-017	1-2
NPN Magneto Resistive Sensor with Quick Disconnect*	047M, 056M, 088M, 125M	OHSN-017	1-2
PNP Magneto Resistive Sensor with Quick Disconnect*	175M, 250M	OHSP-015	1-2
NPN Magneto Resistive Sensor with Quick Disconnect*	175M, 250M	OHSN-015	1-2
PNP Magneto Resistive Sensor (90° barrel) w/Qk. Disc.*	047M, 056M, 088M, 125M	OHSP-011	1-2
NPN Magneto Resistive Sensor (90° barrel) w/Qk. Disc.*	047M, 056M, 088M, 125M	OHSN-011	1-2
Quick Disconnect 2 Meter Cable Length*	All Models	CABL-010	1-2
Quick Disconnect 5 Meter Cable Length*	All Models	CABL-013	1-2

Pneumatic Accessories	Model Numbers	Part Number	Qty/Unit
Plumbing Fitting - M3 male to 3mm OD Tube Push-in Style	047M, 056M	PLFT-021	1-2
Plumbing Fitting - M3 male to 2mm ID Tube Barb Style	047M, 056M	PLFT-022	1-2
Plumbing Fitting - 1/8 NPT Male to 1/8 BSPP Female	125M, 250M	PLFT-028	1-2
Adjustable Flow Control G 1/8 Elbow - 6mm OD Push-in	125M, 250M	VLVF-005	1-2
Adjustable Flow Control M5 Elbow - 6mm OD Push-in	088M, 125M	VLVF-008	1-2
Fail Safe Valve M5	088M, 125M	OFSV-004	1
Fail Safe Valve G 1/8 (1/8 BSPP)	175M, 250M	OFSV-005	1

*Sensor and cable sold separately.

DPDS SERIES

2-Jaw General Industrial Grippers

How To Order

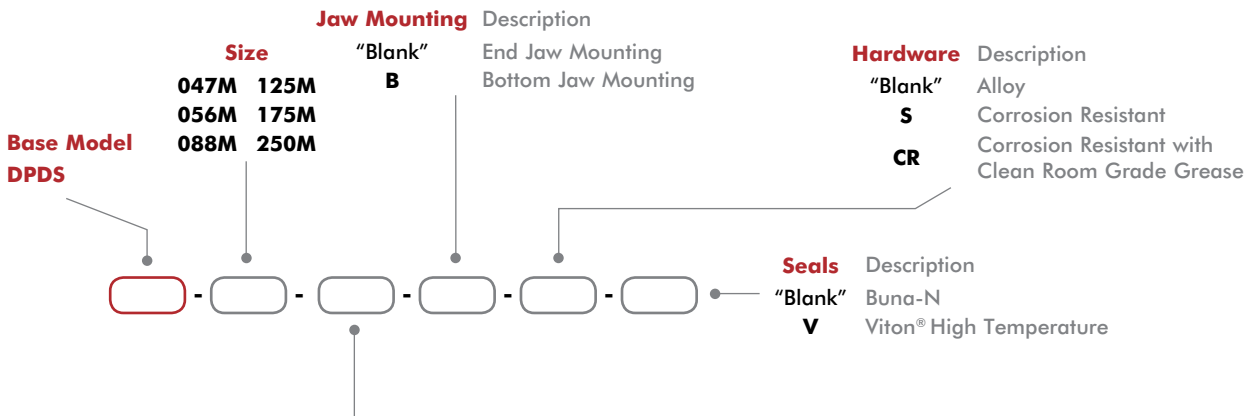
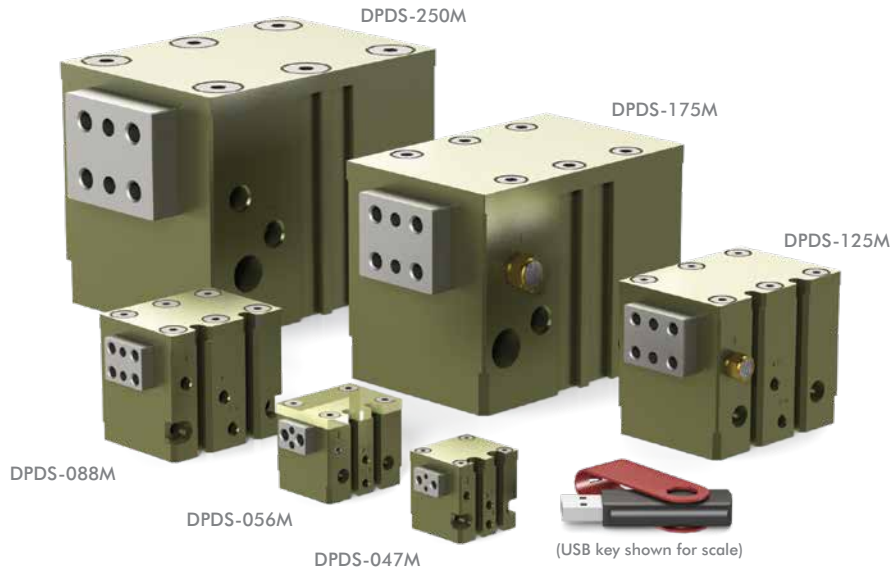

Stroke Stroke varies with size of gripper

047M	006, 009 or 013	125M	019, 025 or 038
056M	009, 013 or 019	175M	025, 038 or 050
088M	013, 019 or 025	250M	038, 050 or 075

Stroke dimensions			
006	1.6mm [0.06]	019	4.8mm [0.19]
009	2.4mm [0.09]	025	6.4mm [0.25]
013	3.2mm [0.13]	038	9.5mm [0.38]
050	12.7mm [0.50]	075	19.1mm [0.75]

Size	Total Rated Grip Force @100 psi [7 bar] N [lbs]	Total Stroke mm [in]
-047M	62 [14]	3.2 [0.13]
-056M	98 [22]	4.8 [0.19]
-088M	222 [50]	6.4 [0.25]
-125M	445 [100]	9.5 [0.38]
-175M	890 [200]	12.7 [0.50]
-250M	1779 [400]	19.1 [0.75]

Size	Seal Repair Kits		
	Buna-N	Viton®	Manifold (Viton®)
-047M	SLKT-185	SLKT-185V	SLKT-197V
-056M	SLKT-186	SLKT-186V	
-088M	SLKT-187	SLKT-187V	SLKT-199V
-125M	SLKT-188	SLKT-188V	
-175M	SLKT-189	SLKT-189V	SLKT-201V
-250M	SLKT-190	SLKT-190V	

Accessories

Sensor Accessories	Model Numbers	Part Number	Qty/Unit
PNP Magneto Resistive Sensor with Quick Disconnect*	047M, 056M, 088M, 125M	OHSP-017	1-2
NPN Magneto Resistive Sensor with Quick Disconnect*	047M, 056M, 088M, 125M	OHSN-017	1-2
PNP Magneto Resistive Sensor with Quick Disconnect*	175M, 250M	OHSP-015	1-2
NPN Magneto Resistive Sensor with Quick Disconnect*	175M, 250M	OHSN-015	1-2
PNP Magneto Resistive Sensor (90° barrel) w/Qk. Disc.*	047M, 056M, 088M, 125M	OHSP-011	1-2
NPN Magneto Resistive Sensor (90° barrel) w/Qk. Disc.*	047M, 056M, 088M, 125M	OHSN-011	1-2
Quick Disconnect 2 Meter Cable Length*	All Models	CABL-010	1-2
Quick Disconnect 5 Meter Cable Length*	All Models	CABL-013	1-2

Pneumatic Accessories	Model Numbers	Part Number	Qty/Unit
Plumbing Fitting - M3 male to 3mm OD Tube Push-in Style	047M, 056M	PLFT-021	1-2
Plumbing Fitting - M3 male to 2mm ID Tube Barb Style	047M, 056M	PLFT-022	1-2
Plumbing Fitting - 1/8 NPT Male to 1/8 BSPP Female	125M, 250M	PLFT-028	1-2
Adjustable Flow Control G 1/8 Elbow - 6mm OD Push-in	125M, 250M	VLVF-005	1-2
Adjustable Flow Control M5 Elbow - 6mm OD Push-in	088M, 125M	VLVF-008	1-2
Fail Safe Valve M5	088M, 125M	OFSV-004	1
Fail Safe Valve G 1/8 (1/8 BSPP)	175M, 250M	OFSV-005	1

* Sensor and cable sold separately.

RDH SERIES

2-Jaw General Industrial Grippers

How To Order

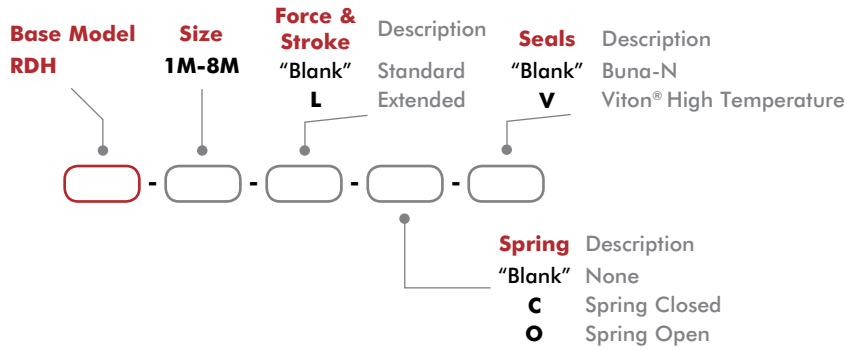
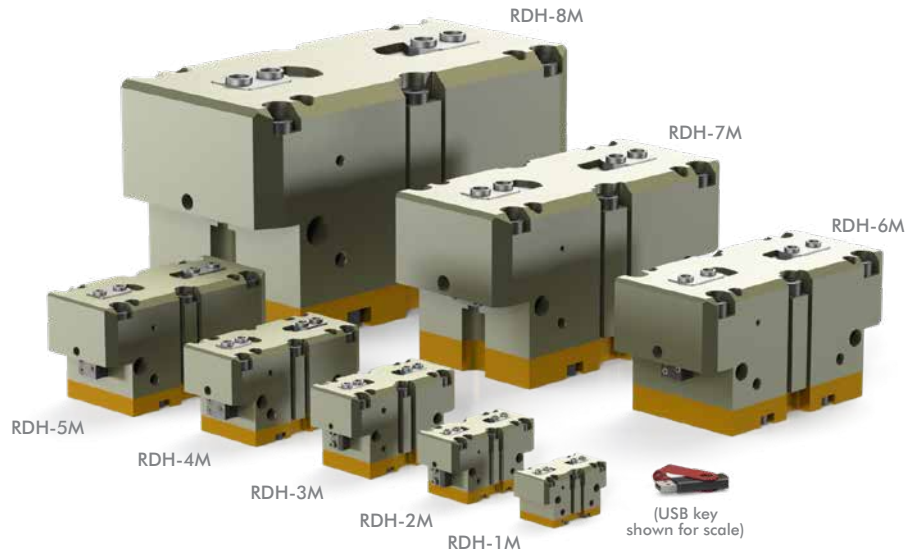

Size	Total Rated Grip Force F @ 100 psi [7 bar] w/o Spring Assist	Total Rated Grip Force F @ 100 psi [7 bar] with Spring Assist	Total Stroke mm [in]
-1M	555 [125]	693 [156]	4 [0.16]
-1M-L	361 [811]	452 [102]	8 [0.32]
-2M	754 [170]	1006 [226]	6 [0.24]
-2M-L	494 [111]	661 [149]	12 [0.47]
-3M	1317 [296]	1683 [379]	8 [0.31]
-3M-L	854 [192]	1094 [246]	16 [0.63]
-4M	2177 [490]	2789 [628]	10 [0.39]
-4M-L	1414 [318]	1814 [408]	20 [0.79]

Size	Total Rated Grip Force F @ 100 psi [7 bar] w/o Spring Assist	Total Rated Grip Force F @ 100 psi [7 bar] with Spring Assist	Total Stroke mm [in]
-5M	3593 [808]	4609 [1037]	13 [0.51]
-5M-L	2333 [525]	2999 [675]	26 [1.02]
-6M	6250 [1406]	8640 [1944]	16 [0.63]
-6M-L	4062 [914]	5623 [1265]	32 [1.26]
-7M	9901 [2228]	12542 [2822]	25 [0.98]
-7M-L	6404 [1441]	8135 [1830]	50 [1.97]
-8M	21958 [4941]	28002 [6300]	35 [1.38]
-8M-L	14178 [3190]	18115 [4076]	70 [2.76]

Size	Seal Repair Kits		Rear Inlet Seal Repair Kit	
	Buna-N	Viton®	Buna-N	Viton®
-1M	SLKT-416	SLKT-416V	SLKT-363	SLKT-363V
-2M	SLKT-417	SLKT-417V		
-3M	SLKT-418	SLKT-418V	SLKT-364	SLKT-364V
-4M	SLKT-419	SLKT-419V		
-5M	SLKT-420	SLKT-420V		
-6M	SLKT-421	SLKT-421V	SLKT-365	SLKT-365V
-7M	SLKT-422	SLKT-422V		
-8M	SLKT-423	SLKT-423V	SLKT-366	SLKT-366V

Accessories

Sensor Accessories	Model Numbers	Part Number	Qty/Unit
8mm PNP Magneto Resistive Sensor (90° barrel) w/ M8 Qk. Disc*	All Models	OHSP-011	1-4
8mm NPN Magneto Resistive Sensor (90° barrel) w/ M8 Qk. Disc*	All Models	OHSN-011	1-4
8mm PNP Magneto Resistive Sensor Short Barrel w/ M8 Qk Disc*	All Models	OHSP-017	1-4
8mm NPN Magneto Resistive Sensor Short Barrel w/ M8 Qk Disc*	All Models	OHSN-017	1-4
8mm PNP Inductive Sensor w/ M12 Quick Disconnect*	RDH-4M, -5M, -6M	OISP-011	1-2
8mm NPN Inductive Sensor w/ M12 Quick Disconnect*	RDH-4M, -5M, -6M	OISN-011	1-2
12mm PNP Inductive Sensor w/ M12 Quick Disconnect*	RDH-7M, -8M	OISP-017	1-2
12mm NPN Inductive Sensor w/ M12 Quick Disconnect*	RDH-7M, -8M	OISN-017	1-2
M8 Quick Disconnect 2 Meter Cable Length*	All Models	CABL-010	1-4
M8 Quick Disconnect 5 Meter Cable Length*	All Models	CABL-013	1-4
M12 Quick Disconnect 2 Meter Cable Length*	RDH-7M, -8M	CABL-014	1-2
M12 Quick Disconnect 5 Meter Cable Length*	RDH-7M, -8M	CABL-018	1-2

Pneumatic Accessories	Model Numbers	Part Number	Qty/Unit
M5 Adjustable Flow Control	RDH-1M, -2M, -3M	VLVF-008	1-2
G 1/4" Adjustable Flow Control	RDH-4M, -5M, -6M, -7M	VLVF-005	1-2
G 1/8" Adjustable Flow Control	RDH-8M	VLVF-010	1-2

*Sensor and cable sold separately.

DPG SERIES

2-Jaw General Industrial Grippers

How To Order

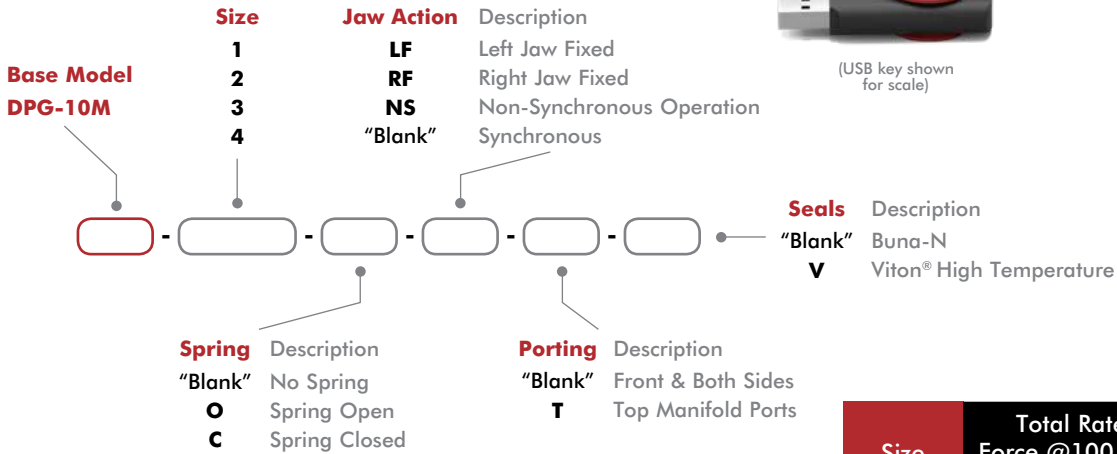

Size	Total Rated Grip Force @100 psi [7 bar] N [lbs]	Total Stroke mm [in]
-10M-1	222 [50]	6.4 [0.25]
-10M-2		12.7 [0.50]
-10M-3		19.1 [0.75]
-10M-4		25.4 [1.00]

Accessories

Sensor Accessories	Model Numbers	Part Number	Qty/Unit
Inductive Sensor Mounting Kit (Mounts 2 Sensors)	All Models	OSMK-097	1-2
NPN Inductive Sensor with Qk. Disconnect*	All Models	OISN-019	1-4
PNP Inductive Sensor with Qk. Disconnect*	All Models	OISP-019	1-4
NPN Magneto Resistive Sensor w/Qk. Disconnect*	All Models	OHSN-017	1-4
PNP Magneto Resistive Sensor w/Qk. Disconnect*	All Models	OHSP-017	1-4
NPN Magneto Resistive Sensor (90°) w/Qk. Disconnect*	All Models	OHSN-011	1-4
PNP Magneto Resistive Sensor (90°) w/Qk. Disconnect*	All Models	OHSP-011	1-4
Quick Disconnect Cable (2 meters long)*	All Models	CABL-010	1-4
Quick Disconnect Cable (5 meters long)*	All Models	CABL-013	1-4
Quick Disconnect Cable Extension Cord (1 meter long)*	All Models	CABL-015	1-4
Quick Disconnect Cable Extension Cord (2 meters long)*	All Models	CABL-016	1-4

Pneumatic Accessories	Model Numbers	Part Number	Qty/Unit
Buna-N Seal Repair Kit	All Models	SLKT-183	1
Viton® Seal Repair Kit	All Models	SLKT-183V	1
-T Plumbing Fitting - M3 male to 3mm OD Tube Push-in Style	All Models	PLFT-021	1-2
-T Plumbing Fitting - M3 male to 2mm ID Tube Barb Style	All Models	PLFT-022	1-2
Fail Safe Valve - M5 (Metric)	All Models	OFSV-004	1
Adjustable Flow Control (Metric)	All Models	VLVF-008	1-2
Top Port Manifold Seal Kit	All Models	SLKT-184V	1

* Sensor and cable sold separately.

REP2 SERIES

2-Jaw General Industrial Grippers

How To Order

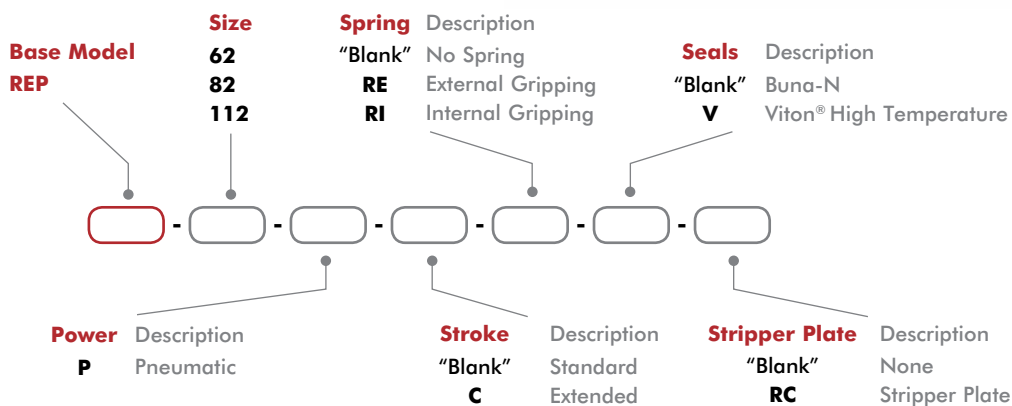

Size	Total Rated Grip Force @100 psi [7 bar]* N [lbs]	Total Stroke mm [in]
-62	771 [173]	10 [0.394]
-62-C	480 [108]	16 [0.630]
-82	2140 [481]	13 [0.512]
-82-C	1382 [311]	20 [0.787]
-112	3351 [753]	30 [1.181]
-112-C	2233 [502]	30 [1.181]

Size	Seal Repair Kits	
	Buna-N	Viton®
-62P	SLKT-155	SLKT-155V
-82P	SLKT-157	SLKT-157V
-112P	SLKT-158	SLKT-158V

*With springs

Accessories

Sensor Accessories	Model Numbers	Part Number	Qty/Unit
NPN Inductive Sensor with M8 Quick Disconnect*	All Models	OISN-011	1-4
PNP Inductive Sensor with M8 Quick Disconnect*	All Models	OISP-011	1-4
NPN Magneto Resistive Sensor with Quick Disconnect*	All Models	OHSN-006	1-2
PNP Magneto Resistive Sensor with Quick Disconnect*	All Models	OHSP-006	1-2
NPN Magneto Resistive Sensor (Short Barrel) with Qk Disconnect*	All Models	OHSN-008	1-2
PNP Magneto Resistive Sensor (Short Barrel) with Qk Disconnect*	All Models	OHSP-008	1-2
M8 Quick Disconnect 2 Meter Cable Length*	All Models	CABL-010	1-4
M8 Quick Disconnect 2 Meter Cable Length*	All Models	CABL-013	1-4
Inductive Sensor Mounting Kit (Mounts 2 Sensors)	62	SD-REP-62	1-2
Inductive Sensor Mounting Kit (Mounts 2 Sensors)	82	SD-REP-82	1-2
Inductive Sensor Mounting Kit (Mounts 2 Sensors)	112	SD-REP-112	1-2

*Sensor and cable sold separately.

RP5-10 SERIES

2-Jaw General Industrial Grippers

How To Order

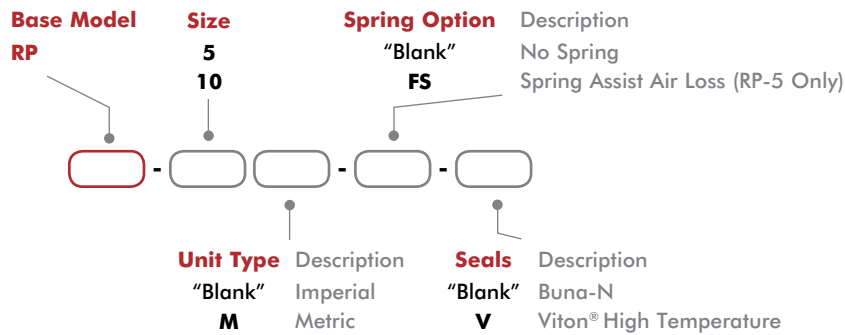
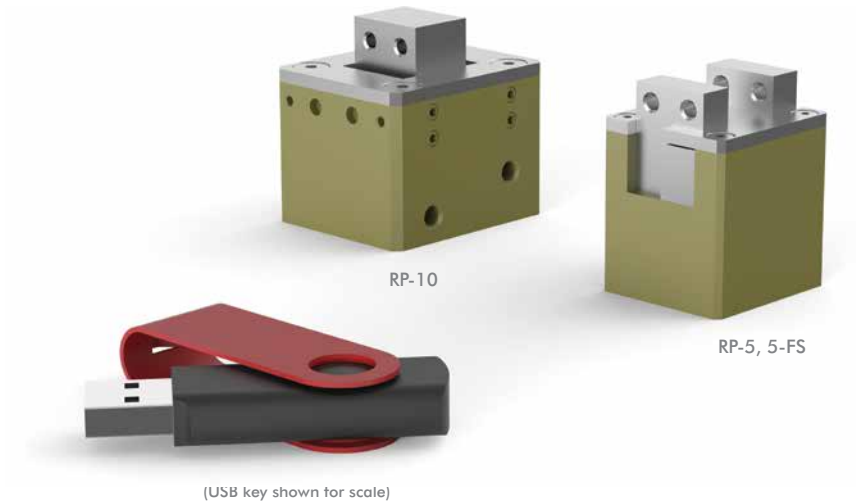

Size	Total Rated Grip Force @100 psi [7 bar] N [lbs]	Total Stroke mm [in]	Seal Repair Kits	
			Buna-N	Viton®
-5	156 [35]	4.1 [0.16]	-5	SLKT-152V
-5-FS	178 [40]		-10	SLKT-136V
-10				

Accessories

Sensor Accessories	Model Numbers	Part Number	Qty/Unit
Sensor Mounting Kit for Imperial & Metric Units (mounts 2 sensors)	RP-5	OSMK-001	1
Sensor Mounting Kit for Imperial & Metric Units (mounts 2 sensors)	RP-10	OSMK-002	1
NPN Inductive Sensor with Quick Disconnect*	All Models	OISN-019	1-2
PNP Inductive Sensor with Quick Disconnect*	All Models	OISP-019	1-2
Quick Disconnect 2 Meter Cable Length*	All Models	CABL-010	1-2
Quick Disconnect 5 Meter Cable Length*	All Models	CABL-013	1-2

Pneumatic Accessories	Model Numbers	Part Number	Qty/Unit
Fail Safe Valve (Imperial)	All Models	OFSV-001	1
Fail Safe Valve (Metric)	All Models	OFSV-004	1

* Sensor and cable sold separately.

How To Order

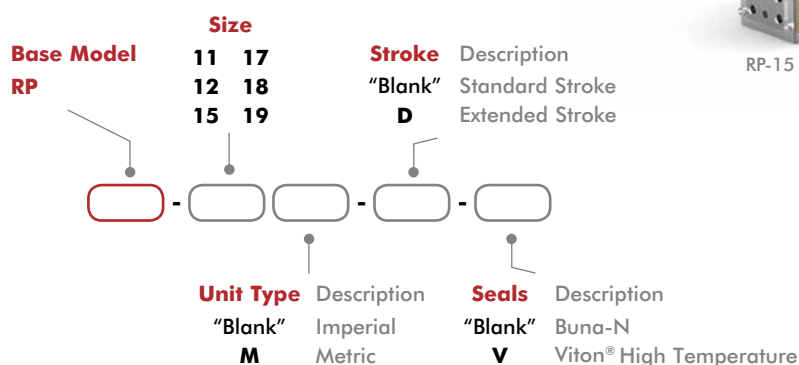
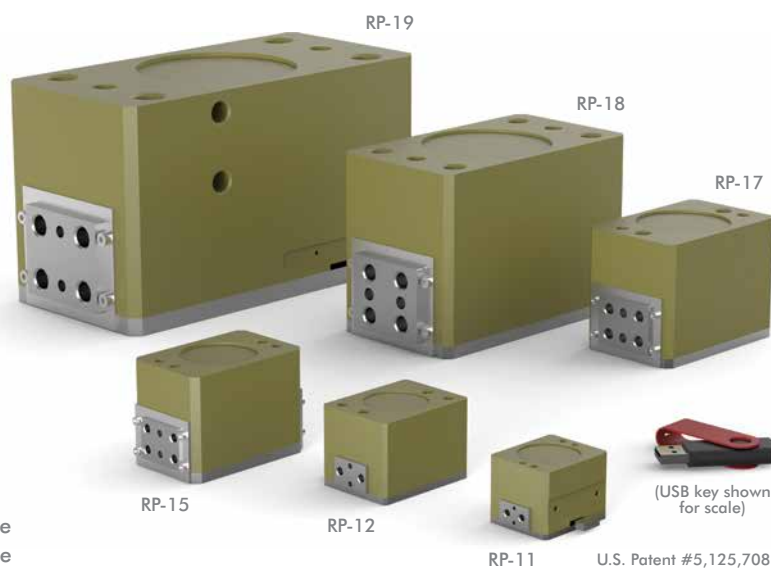

Size	Total Rated Grip Force @ 100 psi [7 bar] N [lbs]	Total Stroke mm [in]
-11	178 [40]	6.4 [0.25]
-12		9.5 [0.38]
-15	311 [70]	12.7 [0.50]
-17	979 [220]	19.1 [0.75]
-18	400 [1779]	31.8 [1.25]
-19	2669 [600]	50.8 [2.00]

Size	Seal Repair Kits		Fail Safe Valve		Inductive Sensor Mtg Kit (mounts 2 sensors)
	Buna-N	Viton®	Imperial	Metric	
-11	SLKT-036	SLKT-036V	OFSV-001	OFSV-004	OSMK-003
-12	SLKT-040	SLKT-040V			
-15	SLKT-041	SLKT-041V	OFSV-002	OFSV-005	
-17	SLKT-042	SLKT-042V			
-18	SLKT-043	SLKT-043V	OFSV-003	OFSV-006	OSMK-073
-19	SLKT-044	SLKT-044V			

Accessories

Sensor Accessories	Model Numbers	Part Number	Qty/Unit
Sensor Mounting Kit for Imperial & Metric Units (mounts 2 sensors)	See Datasheet		1
NPN Inductive Sensor with Quick Disconnect*	11, 12, 15	OISN-019	1-2
PNP Inductive Sensor with Quick Disconnect*	11, 12, 15	OISP-019	1-2
NPN Inductive Sensor with Quick Disconnect*	17, 18, 19	OISN-011	1-2
PNP Inductive Sensor with Quick Disconnect*	17, 18, 19	OISP-011	1-2
Quick Disconnect 2 Meter Cable Length*	All Models	CABL-010	1-2
Quick Disconnect 5 Meter Cable Length*	All Models	CABL-013	1-2

Pneumatic Accessories	Model Numbers	Part Number	Qty/Unit
Fail Safe Valve (Imperial)	See Datasheet		1
Fail Safe Valve (Metric)	See Datasheet		1

* Sensor and cable sold separately.

RPM/RPMC SERIES

2-Jaw General Industrial Grippers

How To Order

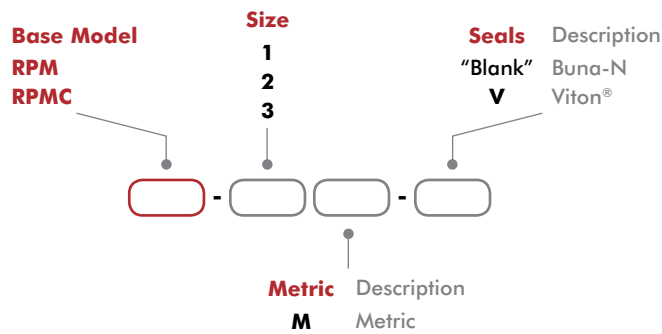
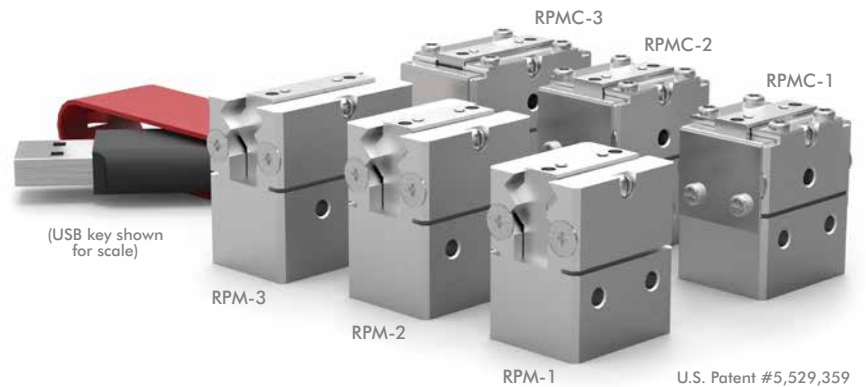

Size	Total Rated Grip Force @100 psi [7 bar] N [lbs]	Total Stroke mm [in]
-1	36 [8]	4.1 [0.16]
-2		4.8 [0.19]
-10		6.3 [0.25]

Accessories

Pneumatic Accessories	Model Numbers	Part Number	Qty/Unit
M3 Plumbing Fitting Push-in for 3mm O.D. Tube	All Models	PLFT-021	2
M3 Plumbing Fitting Barb for 2mm I.D. Tube	All Models	PLFT-022	2
Buna-N Seal Repair Kit	All Models	SLKT-121	1
Viton® Seal Repair Kit	All Models	SLKT-121V	1
Top Air Ports Manifold Seal Kit (available in Viton® only)	All Models (RPM)	SLKT-142V	1
Top Air Ports Manifold Seal Kit (available in Viton® only)	All Models (RPMC)	SLKT-143V	1

How To Order

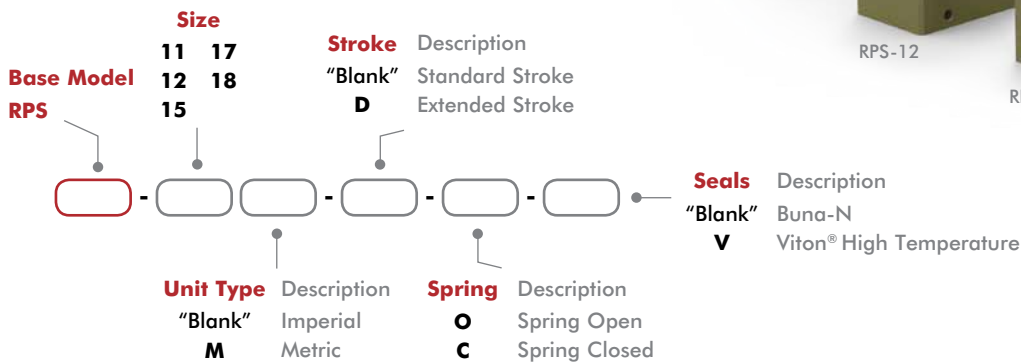

(USB key shown for scale)

U.S. Patent #5,125,708

Size	Total Rated Grip Force @ 100 psi [7 bar] N [lbs]	Total Stroke mm [in]
-11	222 [50]	6.4 [0.25]
-12	267 [60]	9.5 [0.38]
-15	400 [90]	12.7 [0.50]
-17	1334 [300]	19.1 [0.75]
-18	2669 [600]	31.8 [1.25]

Size	Seal Repair Kits		Fail Safe Valve		Inductive Sensor Mtg Kit (mounts 2 sensors)
	Buna-N	Viton®	Imperial	Metric	
-11	SLKT-036	SLKT-036V	OFSV-001	OFSV-004	OSMK-003
-12	SLKT-040	SLKT-040V			
-15	SLKT-041	SLKT-041V			
-17	SLKT-042	SLKT-042V	OFSV-002	OFSV-005	OSMK-072
-18	SLKT-043	SLKT-043V			

Accessories

Sensor Accessories	Model Numbers	Part Number	Qty/Unit
Sensor Mounting Kit for Imperial & Metric Units (mounts 2 sensors)	See Datasheet		1
NPN Inductive Sensor with Quick Disconnect*	11, 12, 15	OISN-019	1-2
PNP Inductive Sensor with Quick Disconnect*	11, 12, 15	OISP-019	1-2
NPN Inductive Sensor with Quick Disconnect*	17, 18	OISN-011	1-2
PNP Inductive Sensor with Quick Disconnect*	17, 18	OISP-011	1-2
Quick Disconnect 2 Meter Cable Length*	All Models	CABL-010	1-2
Quick Disconnect 5 Meter Cable Length*	All Models	CABL-013	1-2

Pneumatic Accessories	Model Numbers	Part Number	Qty/Unit
Fail Safe Valve (Imperial)	See Datasheet		1
Fail Safe Valve (Metric)	See Datasheet		1

* Sensor and cable sold separately.

DPW SERIES

2-Jaw Heavy-Duty Parallel Grippers

How To Order

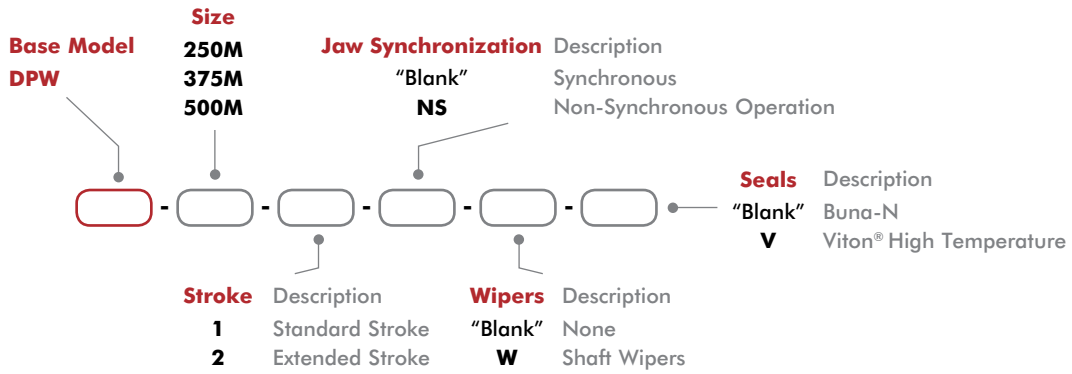

Size	Total Rated Grip Force @100 psi [7 bar] N [lbs]	Total Stroke
250M-1	222 [50]	19.1 [0.75]
250M-2		31.8 [1.25]
375M-1	445 [100]	25.4 [1.00]
375M-2		50.8 [2.00]
500M-1	800 [180]	38.1 [1.50]
500M-2		63.5 [2.50]

Size	Seal Repair Kits		Manifold Seal Kit Viton®	Shaft Wiper Seal Kit	Inductive Sensor Mtg Kit (3mm or 4mm)
	Buna-N	Viton®			
250M	SLKT-337	SLKT-337V	SLKT-197V	SLKT-338	OSMK-116
375M	SLKT-339	SLKT-339V		SLKT-340	OSMK-117
500M	SLKT-341	SLKT-341V	SLKT-199V	SLKT-342	OSMK-118

Accessories

Sensor Accessories	Model Numbers	Part Number	Qty/Unit
PNP Magneto Resistive Sensor Short Barrel (with Qk. Disc.)*	All Models	OHSP-017	1-4†
NPN Magneto Resistive Sensor Short Barrel (with Qk. Disc.)*	All Models	OHSN-017	1-4†
PNP Magneto Resistive Sensor 90° Barrel (with Qk. Disc.)*	All Models	OHSP-011	1-4†
NPN Magneto Resistive Sensor 90° Barrel (with Qk. Disc.)*	All Models	OHSN-011	1-4†
PNP Inductive Sensor 3mm with Quick Disconnect*	All Models	OISP-019	1-2
NPN Inductive Sensor 3mm with Quick Disconnect.*	All Models	OISN-019	1-2
PNP Inductive Sensor 4mm with Quick Disconnect*	375M, 500M	OISP-014	1-2
NPN Inductive Sensor 4mm with Quick Disconnect*	375M, 500M	OISN-014	1-2
Quick Disconnect 2 Meter Cable Length*	All Models	CABL-010	1-4†
Quick Disconnect 5 Meter Cable Length*	All Models	CABL-013	1-4†

Pneumatic Accessories	Model Numbers	Part Number	Qty/Unit
Fail Safe Valve M5	All Models	OFSV-004	1
Adjustable Flow Control	All Models	OFSV-008	1-2

* Sensor and cable sold separately. † Except 250-1, 250-2, 1-2 only.

RPB SERIES

2-Jaw Heavy-Duty Parallel Grippers

How To Order

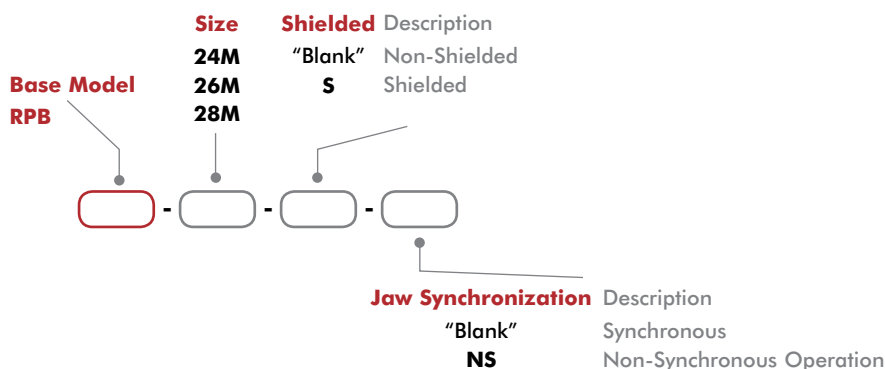

Size	Total Rated Grip Force @100 psi [7 bar] N [lbs]	Total Stroke	Size	Viton® Seal Repair Kits	Shield/Seal Repair Kit -S Only
24M	2669 [600]	101.6 [4]	24M	SLKT-123V	SLKT-152V
26M		152.4 [6]	26M		SLKT-153V
28M		203.2 [8]	28M		SLKT-166V

Accessories

Sensor Accessories	Model Numbers	Part Number	Qty/Unit
12mm Sensor Mounting Kit (mounts 2 sensors)	24, 26, 28	OSMK-078	1-2
12mm Sensor Mounting Kit (mounts 2 sensors)	24-S, 26-S, 28-S	OSMK-079	1-2
12mm PNP Inductive Sensor with Quick Disconnect*	All Models	OISP-017	1-4
12mm NPN Inductive Sensor with Quick Disconnect*	All Models	OISN-017	1-4
Quick Disconnect 2 Meter Cable Length*	All Models	CABL-014	1-4

Pneumatic Accessories	Model Numbers	Part Number	Qty/Unit
Fail Safe Valve (Metric)	All Models	OFSV-006	1
Plumbing Adapter G1/4-M to 1/4 NPT-F	All Models	PLFT-024	1-2

* Sensor and cable sold separately.

RPR SERIES

2-Jaw Heavy-Duty Parallel Grippers

How To Order

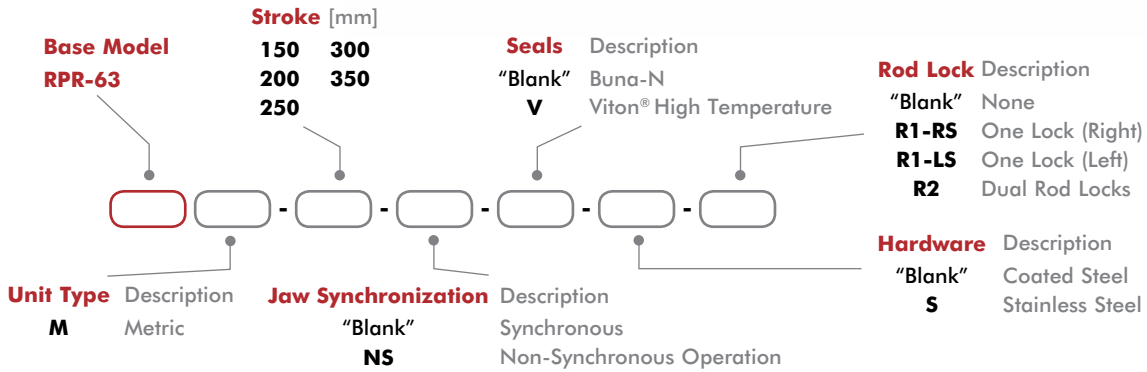

Size	Total Rated Grip Force @100 psi [7 bar] N [lbs]	Total Stroke
RPR-63-200	3250 [800]	200 [7.87]

Accessories

Sensor Accessories	Part Number	Qty/Unit
Sensor Mounting Kit for Imperial & Metric Units (mounts 2 sensors)	OSMK-131	1
12mm PNP Inductive Sensor with Quick Disconnect*	OISP-017	1-2
12mm NPN Inductive Sensor with Quick Disconnect*	OISN-017	1-2
Quick Disconnect 2 Meter Cable Length*	CABL-014	1-2
Quick Disconnect 5 Meter Cable Length*	CABL-018	1-2
Analog Sensor	OISA-001	1
Analog Sensor Cable with Quick Disconnect 5 Meter Cable Length	CABL-045	1
Analog Sensor Mounting Kit	OSMK-132	1

Pneumatic Accessories	Part Number	Qty/Unit
Fail Safe Valve 1/4 NPT (Imperial)	OFSV-003	1
Fail Safe Valve 1/4 BSPP (Metric)	OFSV-006	1
Plumbing Adapter 1/4 BSPP Male to 1/4 NPT Female	PLFT-024	1-2
Buna-N Seal Repair Kit	SLKT-452	1
Viton® Seal Repair Kit	SLKT-453	1

* Sensor and cable sold separately.

RPW SERIES

2-Jaw Heavy-Duty Parallel Grippers

How To Order

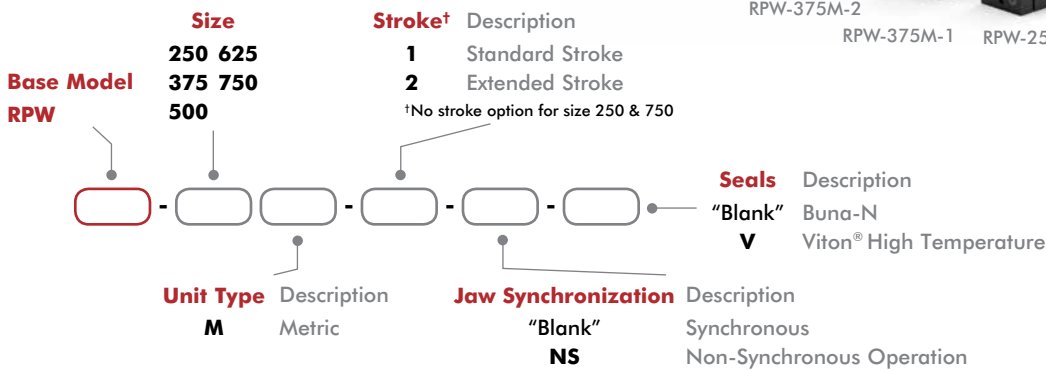

Size	Total Rated Grip Force @100 psi [7 bar] N [lbs]	Total Stroke	Size	Seal Repair Kits	Inductive Sensor Mtg Kit (2 Sensors)
250	222 [50]	19.1 [0.75]	250	SLKT-055 SLKT-055V	OSMK-009
375M-1	400 [90]	25.4 [1.00]	375M-1	SLKT-056 SLKT-056V	OSMK-010
375M-2		50.8 [2.00]	375M-2		OSMK-011
500M-1	667 [150]	38.1 [1.50]	500M-1	SLKT-058 SLKT-058V	OSMK-012
500M-2		63.5 [2.50]	500M-2		OSMK-013
625M-1	1068 [240]	50.8 [2.00]	625M-1	SLKT-071 SLKT-071V	OSMK-074
625M-2		88.9 [3.50]	625M-2		
750	2091 [470]	114.3 [4.50]	750	SLKT-060 SLKT-060V	OSMK-014

Accessories

Sensor Accessories	Model Numbers	Part Number	Qty/Unit
Sensor Mounting Kit for Imperial & Metric Units (mounts 2 sensors)	See Datasheet		1
PNP Inductive Sensor with Quick Disconnect*	250, 375, 500	OISP-014	1-2
NPN Inductive Sensor with Quick Disconnect*	250, 375, 500	OISN-014	1-2
PNP Inductive Sensor with Quick Disconnect*	625, 750	OISP-011	1-2
NPN Inductive Sensor with Quick Disconnect*	625, 750	OISN-011	1-2
Quick Disconnect 2 Meter Cable Length*	All Models	CABL-010	1-2
Quick Disconnect 5 Meter Cable Length*	All Models	CABL-013	1-2

Pneumatic Accessories	Model Numbers	Part Number	Qty/Unit
Fail Safe Valve (Imperial)	250, 375	OFSV-001	1
Fail Safe Valve (Metric)	250, 375	OFSV-004	1
Fail Safe Valve (Imperial)	500, 625, 750	OFSV-002	1
Fail Safe Valve (Metric)	500, 625, 750	OFSV-005	1

* Sensor and cable sold separately.

3P SERIES

3-Jaw Parallel Grippers

How To Order



Note: See catalog for complete options information.

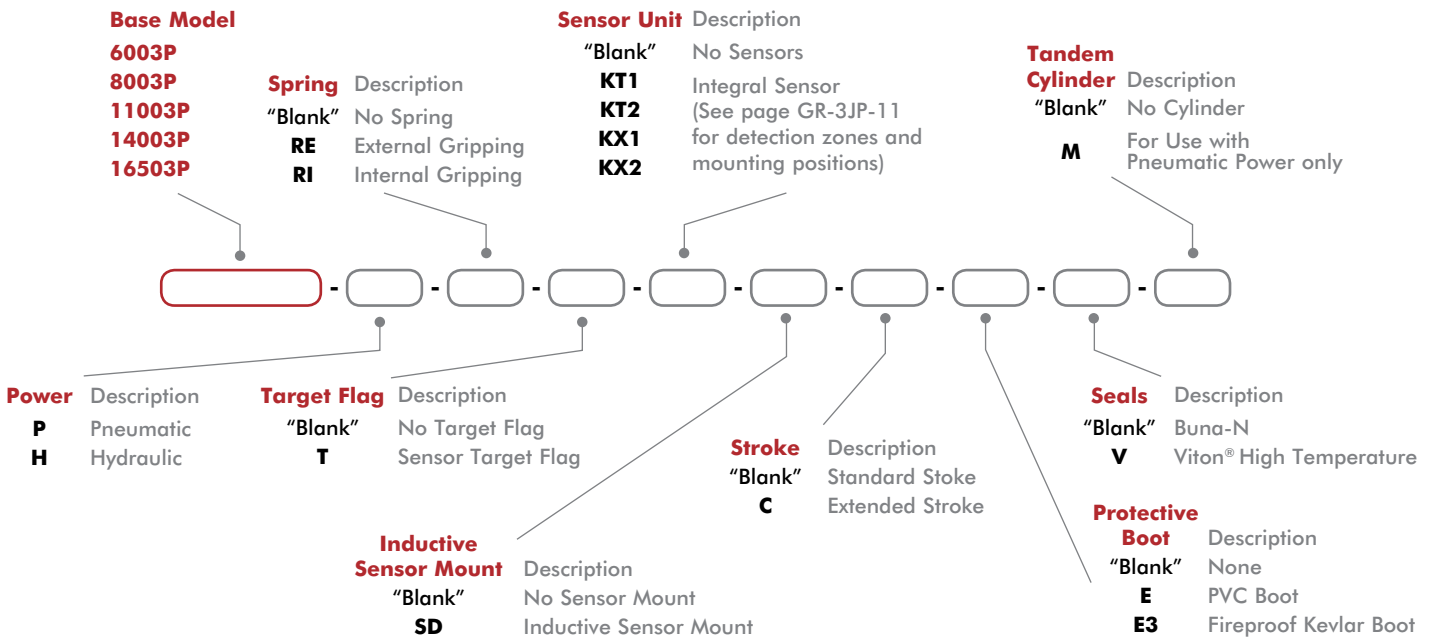

Size	Grip Force (F6+R) 1, 6 bar [87 psi], Springs Mid-Way, L=0 N [lbs]	Grip Force (F0+R) 2, 0 bars, Springs Mid-Way, L=0 N [lbs]	Total Stroke mm [in]
-6003P-P	678 [152]	172 [39]	10 [0.39]
-6003P-P-C	422 [95]	107 [24]	16 [0.63]
-8003P-P	1888 [424]	617 [139]	13 [0.51]
-8003P-P-C	1219 [274]	398 [89]	20 [0.79]
-11003P-P	1979 [445]	628 [141]	
-11003P-P-C	2030 [456]	644 [145]	30 [1.18]

Size	Grip Force (F6+R) 1, 6 bar [87 psi], Springs Mid-Way, L=0 N [lbs]	Grip Force (F0+R) 2, 0 bars, Springs Mid-Way, L=0 N [lbs]	Total Stroke mm [in]
-14503P-P	6077 [1366]	2248 [508]	26 [1.02]
-14503P-P-C	4031 [906]	1490 [335]	40 [1.57]
-16503P-P	11190 [2515]	3730 [838]	30 [1.18]
-16503P-P-C	6878 [1546]	2292 [515]	50 [1.97]

Size	Seal Repair Kits			Protective Boots	
	Buna-N	Viton®	Hydraulic	PVC - Brown or Black	Fireproof KEVLAR - Red
-6003P	SLKT-156	SLKT-156V	SLKT-330	ER63P	E3R63P
-8003P	S80	S80V	S80H	ER83P	E3R83P
-11003P	S100	S110V	S110H	ER113P	E3R113P
-14003P	SLKT-333	SLKT-333	SLKT-334	KP-317	KP-319
-16503P	SLKT-335	SLKT-335V	SLKT-336	KP-320	KP-322

Accessories

Sensor Accessories	Model Numbers	Part Number	Qty/Unit
M8 Inductive Sensor PNP with M8 Connector	6003P, 8003P, 11003P	OISP-011-C	1-4
M8 Inductive Sensor NPN with M8 Connector	6003P, 8003P, 11003P	OISN-011-C	1-4
M8 Inductive Sensor PNP with M12 Connector	14003P, 16503P	OISP-017-C	1-4
M8 Inductive Sensor NPN with M12 Connector	14003P, 16503P	OISN-017-C	1-4
M8 Quick Disconnect 2 Meter Cable Length*	6003P, 8003P, 11003P	CABL-010	1-4
M12 Quick Disconnect 2 Meter Cable Length*	14003P, 16503P	CABL-014	1-4
Inductive Sensor Mounting Kit (1 holder, 1 flag, 2 spacers)	6003P, 8003P	SD60-80P	1-2
Inductive Sensor Mounting Kit (1 holder, 1 flag, 2 spacers)	11003P	SD110P	1-2
Inductive Sensor Mounting Kit (1 holder, 1 flag, 2 spacers)	14003P	OSMK-114	1-2
Inductive Sensor Mounting Kit (1 holder, 1 flag, 2 spacers)	16503P	OSMK-115	1-2

*Sensor and cable sold separately.

RTH SERIES

3-Jaw Parallel Grippers

How To Order

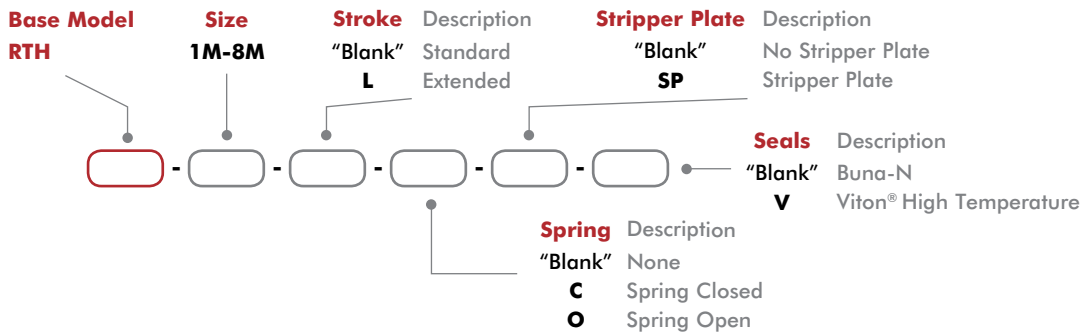
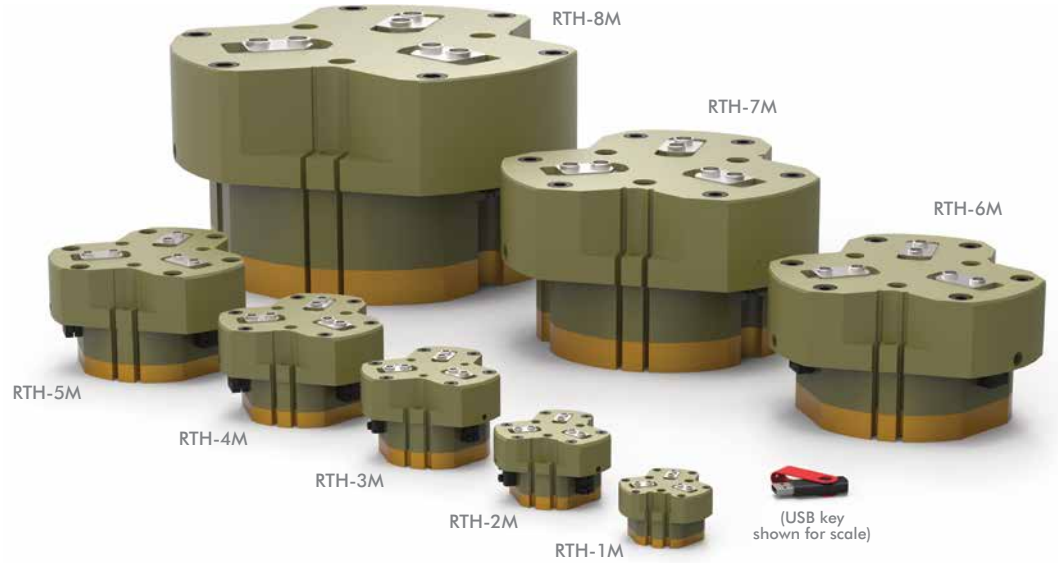

Size	Total Rated Grip Force @100 psi [7 bar] w/o Springs N [lbs]	Total Rated Grip Force @100 psi [7 bar] w/Springs N [lbs]	Total Stroke mm [in]
-1M	682 [153]	889 [200]	4 [0.16]
-1M-L	443 [100]	579 [130]	8 [0.32]
-2M	1238 [278]	1490 [335]	6 [0.24]
-2M-L	812 [183]	979 [220]	12 [0.47]
-3M	2078 [467]	2627 [591]	8 [0.31]
-3M-L	1349 [303]	1708 [384]	16 [0.63]
-4M	3644 [819]	4562 [1026]	10 [0.39]
-4M-L	2366 [532]	2967 [667]	20 [0.79]

*With springs

Size	Total Rated Grip Force @100 psi [7 bar] w/o Springs N [lbs]	Total Rated Grip Force @100 psi [7 bar] w/Springs N [lbs]	Total Stroke mm [in]
-5M	6353 [1428]	7877 [1771]	13 [0.51]
-5M-L	4125 [927]	5124 [1152]	26 [1.02]
-6M	10202 [2294]	13786 [3099]	16 [0.63]
-6M-L	6629 [1490]	8971 [2017]	32 [1.26]
-7M	17165 [3859]	22093 [4967]	25 [0.98]
-7M-L	11102 [2496]	14322 [3222]	50 [1.97]
-8M	35288 [7933]	44354 [9971]	35 [1.38]
-8M-L	22784 [5122]	28690 [6450]	70 [2.76]

*With springs

Size	Seal Repair Kits		Rear Inlet Seal Repair Kits	
	Buna-N	Viton®	Buna-N	Viton®
-1M	SLKT-347	SLKT-347V	SLKT-363	SLKT-363V
-2M	SLKT-348	SLKT-348V		
-3M	SLKT-349	SLKT-349V	SLKT-364	SLKT-364V
-4M	SLKT-350	SLKT-350V	SLKT-365	SLKT-365V

Size	Seal Repair Kits		Rear Inlet Seal Repair Kits	
	Buna-N	Viton®	Buna-N	Viton®
-5M	SLKT-351	SLKT-351V		
-6M	SLKT-352	SLKT-352V	SLKT-365	SLKT-365V
-7M	SLKT-353	SLKT-353V		
-8M	SLKT-354	SLKT-354V	SLKT-366	SLKT-366V

Accessories

Sensor Accessories	Model Numbers	Part Number	Qty/Unit
8mm PNP Magneto Resistive Sensor (90° barrel) w/ M8 Qk. Disc*	All Models	OHSP-011	1-3 [†]
8mm NPN Magneto Resistive Sensor (90° barrel) w/ M8 Qk. Disc*	All Models	OHSN-011	1-3 [†]
8mm PNP Magneto Resistive Sensor Short Barrel w/ M8 Qk Disc*	All Models	OHSP-017	1-3 [†]
8mm NPN Magneto Resistive Sensor Short Barrel w/ M8 Qk Disc*	All Models	OHSN-017	1-3 [†]
8mm PNP Inductive Sensor w/ M12 Quick Disconnect*	RTH-4M, -5M, -6M	OISP-011	1-3
8mm NPN Inductive Sensor w/ M12 Quick Disconnect*	RTH-4M, -5M, -6M	OISN-011	1-3
12mm PNP Inductive Sensor w/ M12 Quick Disconnect*	RTH-7M, -8M	OISP-017	1-3
12mm NPN Inductive Sensor w/ M12 Quick Disconnect*	RTH-7M, -8M	OISN-017	1-3
M8 Quick Disconnect 2 Meter Cable Length*	All Models	CABL-010	1-3
M8 Quick Disconnect 5 Meter Cable Length*	All Models	CABL-013	1-3
M12 Quick Disconnect 2 Meter Cable Length*	RTH-7M, -8M	CABL-014	1-3 [†]
M12 Quick Disconnect 5 Meter Cable Length*	RTH-7M, -8M	CABL-018	1-3 [†]
Pneumatic Accessories	Model Numbers	Part Number	Qty/Unit
M5 Adjustable Flow Control	RTH-1M, -2M, -3M	VLVF-008	1-2
G 1/8" 90° Adjustable Flow Control	RTH-4M, -5M, -6M, -7M	VLVF-005	1-2
G 1/4" Adjustable Flow Control	RDH-8M	VLVF-010	1-2

*Sensor and cable sold separately. [†]Except RTH-1, 1-2 only.

PPC SERIES

3-Jaw Parallel Grippers

How To Order

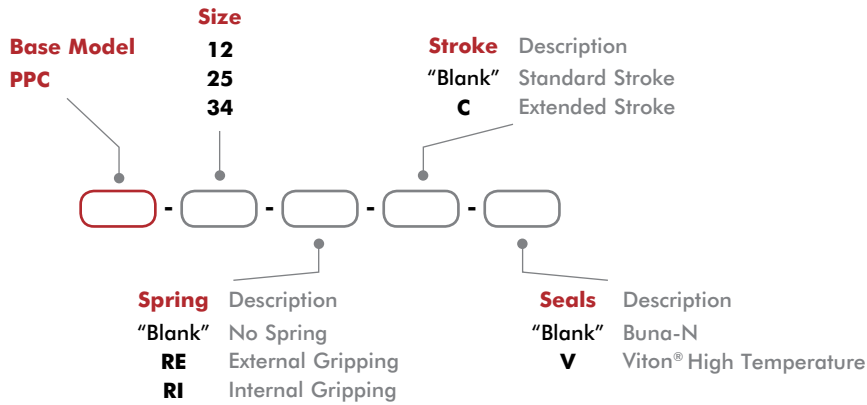

Size	Total Rated Grip Force @100 psi [7 bar]* N [lbs]	Total Stroke mm [in]
-12	1474 [331]	10 [0.394]
-12-C	896 [201]	16 [0.630]
-25	2620 [589]	13 [0.512]
-25-C	1642 [369]	20 [0.787]
-34	4332 [974]	20 [0.787]
-34-C	2938 [638]	30 [1.181]

*With springs

Accessories

Sensor Accessories	Model Numbers	Part Number	Qty/Unit
Inductive Sensor Mounting Kit (1 Holder, 1 Flag, 2 Spacers)	PPC-12	OSMK-105	1-2
Inductive Sensor Mounting Kit (1 Holder, 1 Flag, 2 Spacers)	PPC-25	OSMK-106	1-2
Inductive Sensor Mounting Kit (1 Holder, 1 Flag, 2 Spacers)	PPC-34	OSMK-107	1-2
NPN Inductive Sensor with Quick Disconnect*	All Models	OISN-011	1-4
PNP Inductive Sensor with Quick Disconnect*	All Models	OISP-011	1-4
Quick Disconnect Cable (2 meters long)*	All Models	CABL-010	1-4
Quick Disconnect Cable (5 meters long)*	All Models	CABL-013	1-4

* Sensor and cable sold separately.

REP3 SERIES

3-Jaw Parallel Grippers

How To Order

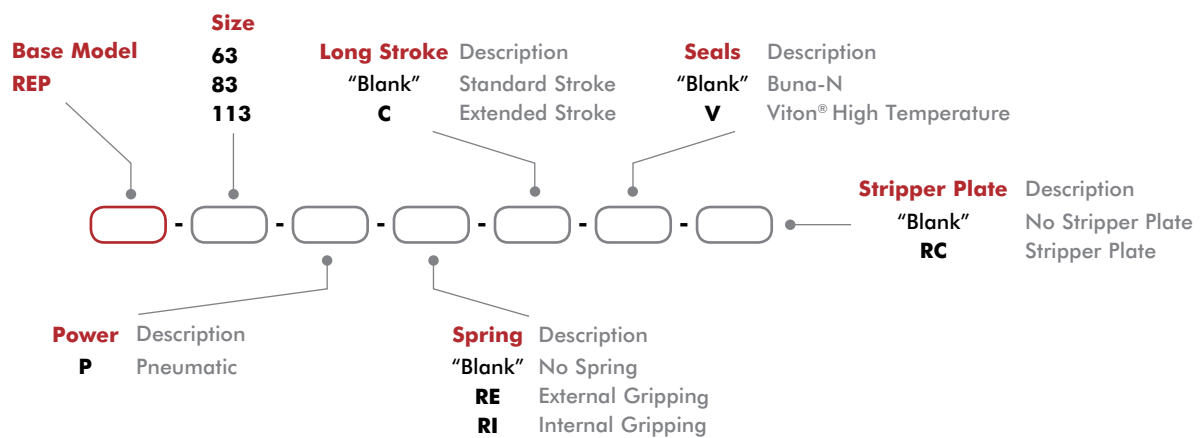

Size	Total Rated Grip Force @100 psi [7 bar]* N [lbs]	Total Stroke mm [in]
-63	753 [169]	10 [0.394]
-63-C	469 [105]	16 [0.630]
-83	2077 [467]	13 [0.512]
-83-C	1341 [301]	20 [0.787]
-113	3268 [735]	20 [0.787]
-113-C	2180 [490]	30 [1.181]

Size	Seal Repair Kits	
	Buna-N	Viton®
-63P	SLKT-155	SLKT-155V
-83P	SLKT-157	SLKT-157V
-113P	SLKT-158	SLKT-158V

*With springs

Accessories

Sensor Accessories	Model Numbers	Part Number	Qty/Unit
NPN Inductive Sensor with M8 Quick Disconnect*	All Models	OISN-011	1-4
PNP Inductive Sensor with M8 Quick Disconnect*	All Models	OISP-011	1-4
NPN Magneto Resistive Sensor with Quick Disconnect*	All Models	OHSN-006	1-2
PNP Magneto Resistive Sensor with Quick Disconnect*	All Models	OHSP-006	1-2
NPN Magneto Resistive Sensor (Short Barrel) with Qk Disconnect*	All Models	OHSN-008	1-2
PNP Magneto Resistive Sensor (Short Barrel) with Qk Disconnect*	All Models	OHSP-008	1-2
M8 Quick Disconnect 2 Meter Cable Length*	All Models	CABL-010	1-4
M8 Quick Disconnect 2 Meter Cable Length*	All Models	CABL-013	1-4
Inductive Sensor Kit (Mounts 2 Sensors)	63	OSMK-105	1-2
Inductive Sensor Kit (Mounts 2 Sensors)	83	OSMK-106	1-2
Inductive Sensor Kit (Mounts 2 Sensors)	113	OSMK-107	1-2

*Sensor and cable sold separately.

RPC SERIES

3-Jaw Parallel Grippers

How To Order

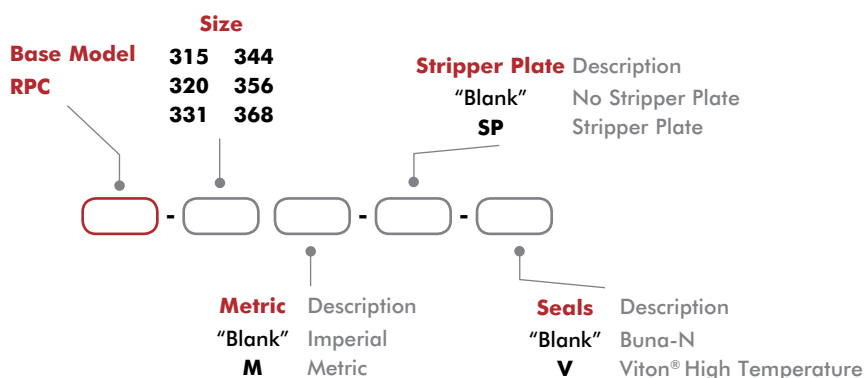

Size	Total Rated Grip Force @100 psi [7 bar]* N [lbs]	Total Stroke mm [in]
-315	445 [100]	7.6 [0.30]
-320	1334 [300]	10.2 [0.40]
-331	3336 [750]	15.7 [0.62]
-344	4003 [900]	22.2 [0.88]
-356		28.4 [1.12]
-368	13345 [3000]	34.9 [1.38]

*With springs

Accessories

Sensor Accessories	Model Numbers	Part Number	Qty/Unit
4mm NPN Magneto Resistive Sensor with Quick Disconnect*	All Models	OHSN-017	1-2
4mm PNP Magneto Resistive Sensor with Quick Disconnect*	All Models	OHSP-017	1-2
4mm NPN 90° Magneto Resistive Sensor with Quick Disconnect*	All Models	OHSN-011	1-2
4mm PNP 90° Magneto Resistive Sensor with Quick Disconnect*	All Models	OHSP-011	1-2
Quick Disconnect Cable (2 meters long)*	All Models	CABL-010	1-2
Quick Disconnect Cable (5 meters long)*	All Models	CABL-013	1-2
Fail Safe Valve (Imperial)	315, 320, 331	OFSV-001	1
Fail Safe Valve (Metric)	315, 320, 331	OFSV-004	1
Fail Safe Valve (Imperial)	344, 356, 368	OFSV-002	1
Fail Safe Valve (Metric)	344, 356, 368	OFSV-005	1

*Sensor and cable sold separately.

CT/DCT & CT-RE/DCT-RE SERIES

Angular Grippers

How To Order

Base Model

DCT (sizes 12-25 only)
CT (sizes 32-50 only)

Size

12M 25M 50M
16M 32M
20M 40M

Seals

"Blank"
V

Description
Buna-N
Viton® High Temperature

Spring

"Blank"
RE

Description
None
Spring Closed

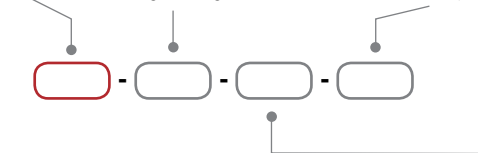

Size	Total Rated Grip Force 100 psi [7 bar] N [lbs]	Stroke (degree per finger)
12M	32 [7.2]	90°
12M-RE	40 [9]	
16M	70 [16]	
16M-RE	87 [19]	
20M	112 [25]	
20M-RE	141 [32]	
25M	157 [35]	
25M-RE	199 [45]	
32M	272 [61]	
32M-RE	353 [79]	
40M	446 [100]	
40M-RE	592 [133]	
50M	651 [146]	
50M-RE	893 [201]	

Size	Seal Repair Kits		Adjustment Stop Kit (1 shielded plate, 1 stop)	Inductive Sensor Mounting Kit (mounts 2 sensors)
	Buna-N	Viton®		
12M/12M-RE	SLKT-159	SLKT-159V	KP-DCT12-BR	N/A
16M/16M-RE	SLKT-160	SLKT-160V	KP-DCT16-BR	SDCT-16-20
20M/20M-RE	SLKT-161	SLKT-161V	KP-DCT20-BR	
25M/25M-RE	SLKT-162	SLKT-162V	KP-DCT25-BR	
32M/32M-RE	SLKT-163	SLKT-163V	KP-DCT32-BR	SDCT-25-32
40M/40M-RE	SLKT-164	SLKT-164V	KP-DCT40-BR	
50M/50M-RE	SLKT-165	SLKT-165V	KP-DCT50-BR	SDCT-40-63

Accessories

Sensor Accessories	Model Numbers	Part Number	Qty/Unit
NPN Magneto Resistive Sensor with M8 Quick Disconnect	All Models	OHSN-017	1-2
PNP Magneto Resistive Sensor with M8 Quick Disconnect	All Models	OHSP-017	1-2
Inductive Sensor Mounting Kit (mounts 2 sensors)	See Above		1
4mm NPN Inductive Sensor with M8 Quick Disconnect*	16M, 20M	OISN-014	1-2
4mm PNP Inductive Sensor M8 with Quick Disconnect*	16M, 20M	OISP-014	1-2
M8 NPN Inductive Sensor with M8 Quick Disconnect*	25M, 32M	OISN-011	1-2
M8 PNP Inductive Sensor with M8 Quick Disconnect*	25M, 32M	OISP-011	1-2
M12 NPN Inductive Sensor with M12 Quick Disconnect*	40M, 50M	OISN-017	1-2
M12 PNP Inductive Sensor with M12 Quick Disconnect*	40M, 50M	OISP-017	1-2
M8 Quick Disconnect 2 Meter Cable Length*	All Models	CABL-010	1-2
M8 Quick Disconnect 5 Meter Cable Length*	All Models	CABL-013	1-2
M12 Quick Disconnect 2 Meter Cable Length*	All Models	CABL-014	1-2
M12 Quick Disconnect 5 Meter Cable Length*	All Models	CABL-018	1-2

Pneumatic Accessories	Model Numbers	Part Number	Qty/Unit
Adjustable Flow Control-M5 Elbow-6mm OD Push-in	12M, 16M, 20M, 25M, 32M	VLVF-008	1-2
Adjustable Flow Control-G1/8 Elbow-6mm OD Push-in	40M, 50M	VLVF-005	1-2

* Sensor and cable sold separately.

RA (CAM DRIVEN) SERIES

Angular Grippers

How To Order

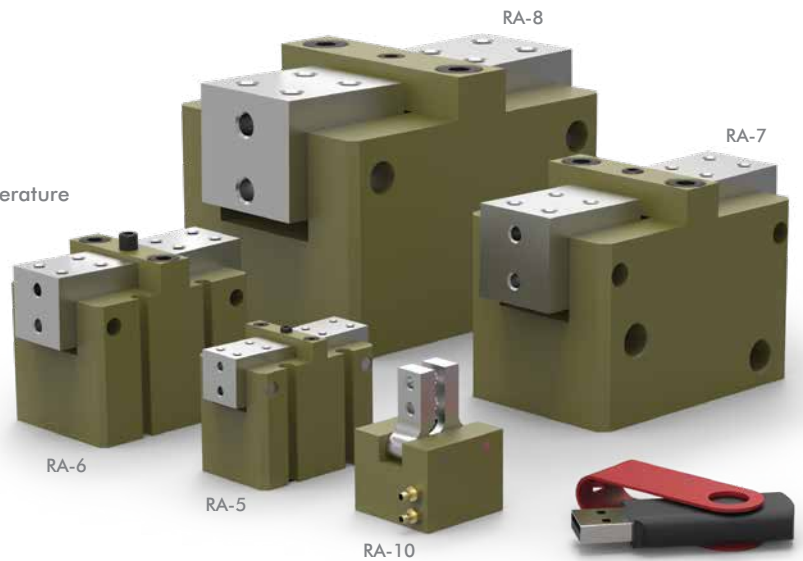
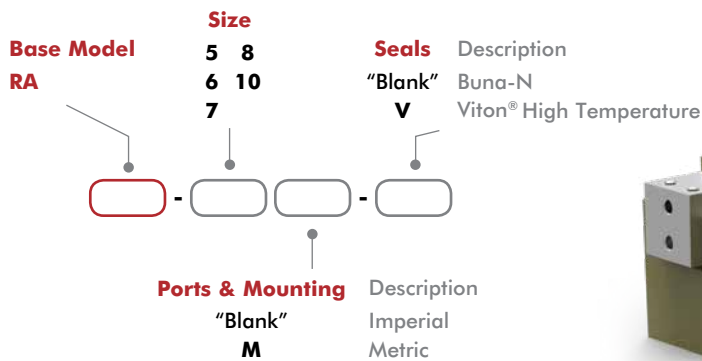

Size	Total Rated Grip Force 100 psi [7 bar] N [lbs]	Stroke (degree per finger)
5	89 [20]	15°
6	196 [44]	
7	534 [120]	
8	801 [180]	
10	71 [16]	

Size	Seal Repair Kits	
	Buna-N	Viton®
5	SLKT-022	SLKT-022V
6	SLKT-023	SLKT-023V
7	SLKT-118	SLKT-118V
8	SLKT-119	SLKT-119V
10	SLKT-018	SLKT-018V

Accessories

Sensor Accessories	Model Numbers	Part Number	Qty/Unit
NPN Magneto Resistive Sensor with Quick Disconnect*	5, 6, 7, 8	OHSN-017	1-2
PNP Magneto Resistive Sensor with Quick Disconnect*	5, 6, 7, 8	OHSP-017	1-2
NPN Magneto Resistive Sensor 90° with Quick Disconnect*	5, 6, 7, 8	OHSN-011	1-2
PNP Magneto Resistive Sensor 90° with Quick Disconnect*	5, 6, 7, 8	OHSP-011	1-2
Quick Disconnect 2 Meter Cable Length*	5, 6, 7, 8	CABL-010	1-2
Quick Disconnect 5 Meter Cable Length*	5, 6, 7, 8	CABL-013	1-2

Pneumatic Accessories	Model Numbers	Part Number	Qty/Unit
Fail Safe Valve (Imperial)	5, 6	OFSV-001	1
Fail Safe Valve (Metric)	5, 6	OFSV-004	1
Fail Safe Valve (Imperial)	7, 8	OFSV-002	1
Fail Safe Valve (Metric)	7, 8	OFSV-005	1

*Sensor and cable sold separately.

RA (TOGGLE LOCK) SERIES

Angular Grippers

How To Order

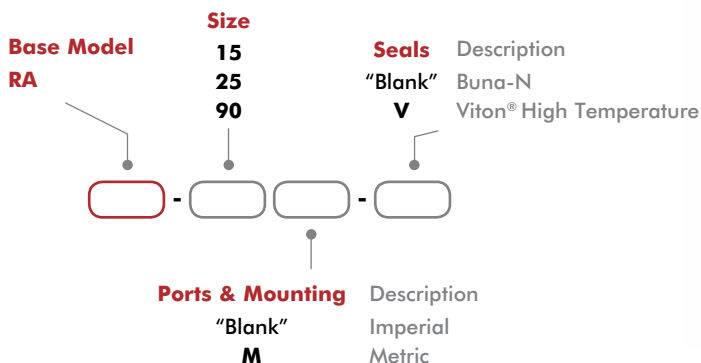

Size	Total Rated Grip Force 100 psi [7 bar] N [lbs]	Stroke (degree per finger)	Size	Inductive Sensor Mounting Kit (mounts 2 sensors)		Seal Repair Kits	
				Buna-N	Viton®		
15	311 [70]	6°	15	OSMK-018	SLKT-019	SLKT-019V	
25	1112 [250]		25	OSMK-019	SLKT-020	SLKT-020V	
90	356 [80]	90°	90	OSMK-003	SLKT-024	SLKT-024V	

Accessories

Sensor Accessories	Model Numbers	Part Number	Qty/Unit
Sensor Mounting Kit, Mounts 2 Inductive Sensors (Imperial/Metric)	See Datasheet		1
NPN Inductive Sensor with Quick Disconnect*	15	OISN-019	1-2
PNP Inductive Sensor with Quick Disconnect*	15	OISP-019	1-2
NPN Inductive Sensor with Quick Disconnect*	25	OISN-014	1-2
PNP Inductive Sensor with Quick Disconnect*	25	OISP-014	1-2
NPN Inductive Sensor with Quick Disconnect*	90	OISN-013	1-2
PNP Inductive Sensor with Quick Disconnect*	90	OISP-013	1-2
NPN Magneto Resistive Sensor with Quick Disconnect*	90	OHSN-008	1-2
PNP Magneto Resistive Sensor with Quick Disconnect*	90	OHSP-008	1-2
NPN Magneto Resistive Sensor 90° with Quick Disconnect*	90	OHSN-011	1-2
PNP Magneto Resistive Sensor 90° with Quick Disconnect*	90	OHSP-011	1-2
Quick Disconnect 2 Meter Cable Length*	All Models	CABL-010	1-2
Quick Disconnect 5 Meter Cable Length*	All Models	CABL-013	1-2
Pneumatic Accessories	Model Numbers	Part Number	Qty/Unit
#10-32 to 1/4" OD Tube Flow Controls	90	VLVF-007	2
M5 to 6mm OD Tube Flow Controls	90	VLVF-008	2

* Sensor and cable sold separately.

RUA SERIES

Angular Grippers

How To Order

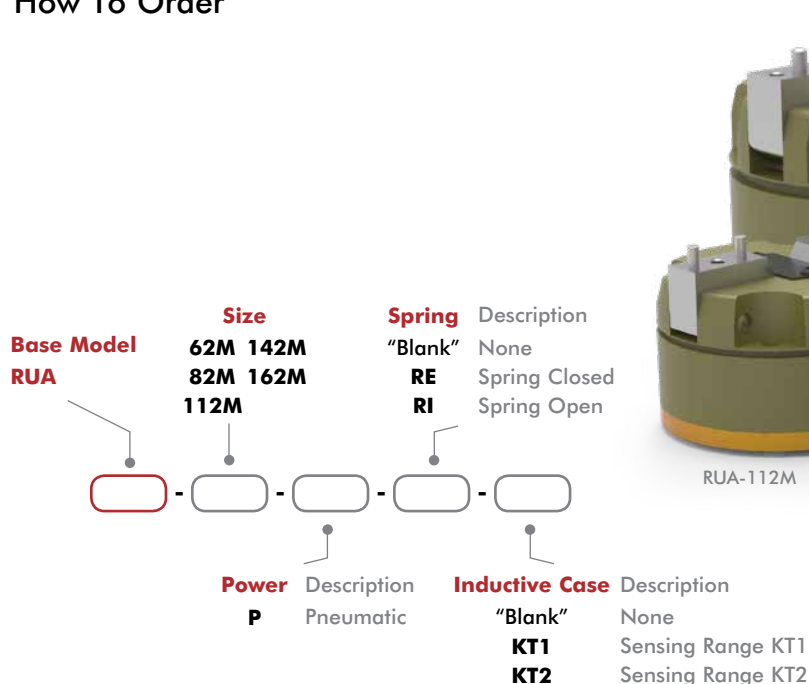

Size	Total Rated Grip Force L=25mm [1 in.] @ 0° N [lbs] 100 psi [7 bar]		Stroke (degree per finger)
	with Spring	without Spring	
62M	384 [86]	313 [70]	16.8°
82M	1228 [276]	922 [207]	15.9°
112M	2150 [483]	1600 [360]	19.1°
142M	5775 [1298]	3941 [886]	17.6°
162M	5490 [1234]	3790 [853]	17.2°

Size	Seal Repair Kits Viton®	Sealed Boots (2 interfaces, 1 collar, 1 boot)	
		PVC	Kevlar
62M	OSMK-156V	SLKT-367	SLKT-368
82M	OSMK-157V	SLKT-370	SLKT-371
112M	OSMK-158V	SLKT-373	SLKT-374
142M	OSMK-333V	SLKT-376	SLKT-377
162M	OSMK-335V	SLKT-379	SLKT-380

Accessories

Sensor Accessories	Model Numbers	Part Number	Qty/Unit
NPN Magneto Resistive Sensor with Quick Disconnect* **	62M, 82M, 112M	OHSN-017	1-2
PNP Magneto Resistive Sensor with Quick Disconnect* **	62M, 82M, 112M	OHSP-017	1-2
NPN Magneto Resistive Sensor 90° with Quick Disconnect* **	62M, 82M, 112M	OHSN-011	1-2
PNP Magneto Resistive Sensor 90° with Quick Disconnect* **	62M, 82M, 112M	OHSP-011	1-2
Replacement PNP Double Inductive Sensor* †	All Models	KT15	1
Quick Disconnect 2 Meter Cable Length*	62M, 82M, 112M	CABL-010	1-2
Quick Disconnect 5 Meter Cable Length*	62M, 82M, 112M	CABL-013	1-2
Quick Disconnect 2 Meter Cable Length (for KT Inductive Sensor)*	All Models	CABL-014	1-2

*Sensor and cable sold separately. **Piston magnet standard. †Requires KT1 or KT2 sensor option.

FUA SERIES

Angular Food Grippers

How To Order

Base Model
FUA-63M

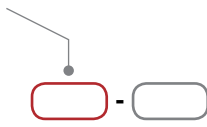

Spring Description
 "Blank" None
C Spring Closed



Specifications	Units	FUA-63M
Torque, Jaws @ 0° (mid-stroke)		
@ 6 bar [87 psi], w/spring	Nm [in-lbs]	32 [283]
@ 0 bar [0 psi], w/spring	Nm [in-lbs]	9 [80]
Total Stroke		70°

DRF SERIES

Rotary Actuators

How To Order

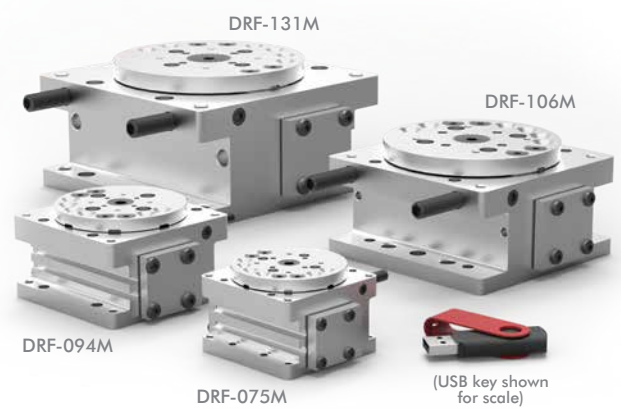
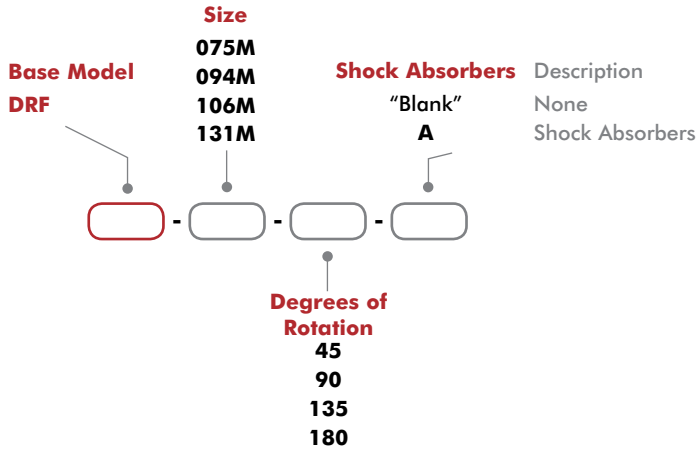

Size	Maximum Payload		Maximum Payload Inertia		Maximum Torque @ 100psi/7 bar Nm [lbs-in]	Maximum Rotation
	Shocks (-A option) kg [lb]	without Shocks kg [lb]	Shocks (-A option) Nm sec ² [in-lbs sec ²]	without Shocks Nm sec ² [in-lbs sec ²]		
075M	0.45 [1.0]	0.23 [0.5]	1.8 X 10 ⁴ [0.0016]	9.0 X 10 ⁵ [0.0008]	0.9 [8.3]	180°
094M	1.4 [3.0]	0.68 [1.5]	1.3 X 10 ³ [0.0111]	6.3 X 10 ⁴ [0.0056]	1.9 [17.3]	
106M	3.6 [8.0]	1.8 [4.0]	4.7 X 10 ³ [0.0414]	2.3 X 10 ³ [0.0207]	3.8 [33.2]	
131M	6.8 [15]	3.4 [7.5]	1.1 X 10 ² [0.0970]	5.5 X 10 ³ [0.0485]	7.6 Nm [67.6]	

Size	Buna-N Seal Repair Kits		Turntables	
	Body	Shock	Blank	DIRECTCONNECT™
075M	SLKT-210	SLKT-214	ODRF-002	ODRF-004
094M	SLKT-216	SLKT-219	ODRF-008	ODRF-010
106M	SLKT-222	SLKT-225	ODRF-014	ODRF-016
131M	SLKT-228	SLKT-232	ODRF-020	ODRF-022

Accessories

Sensor Accessories	Model Numbers	Part Number	Qty/Unit
NPN Magneto Resistive Sensor with Quick Disconnect*	All Models	OHSN-017	1-2
PNP Magneto Resistive Sensor with Quick Disconnect*	All Models	OHSP-017	1-2
NPN Magneto Resistive Sensor 90° Barrel with Quick Disconnect*	All Models	OHSN-011	1-2
PNP Magneto Resistive Sensor 90° Barrel with Quick Disconnect*	All Models	OHSP-011	1-2
Quick Disconnect 2 Meter Cable Length*	All Models	CABL-010	1-2
Quick Disconnect 5 Meter Cable Length*	All Models	CABL-013	1-2

Pneumatic Accessories	Model Numbers	Part Number	Qty/Unit
Fitting Push-in Straight G1/8, 6mm O.D. Tube	131M	PLFT-038	1-2
Fitting Push-in Straight G1/8, 8mm O.D. Tube	131M	PLFT-045	1-2
Flow Control Push-in 90° Elbow M5-6mm O.D. Tube**	075M, 094M, 106M	VLVF-008	1-2
Flow Control Push-in 90° Elbow G1/8-6mm O.D. Tube**	131M	VLVF-005	1-2

* Sensor and cable sold separately.

**Flow Controls recommended for most applications

DRG SERIES

Rotary Actuators

How To Order

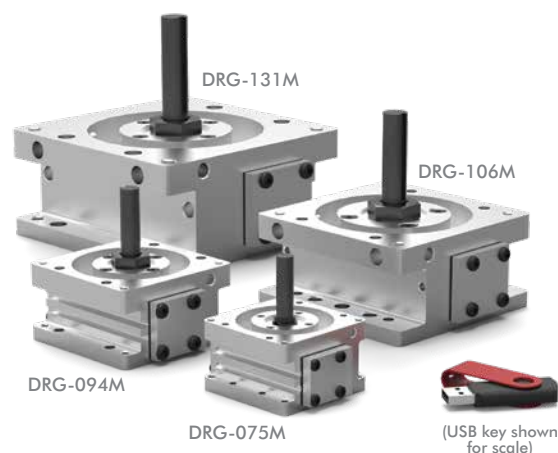
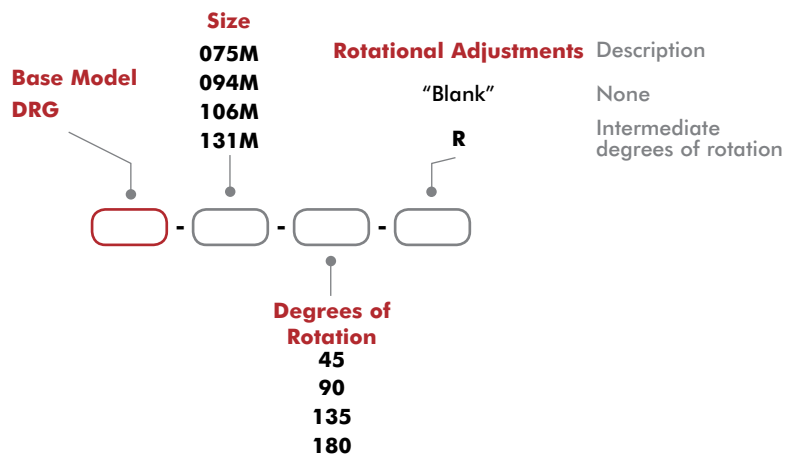

Size	Maximum Payload kg [lb]	Maximum Payload Inertia Nm sec ² [in-lbs sec ²]	Maximum Torque @ 100psi/7 bar Nm [lbs-in]	Maximum Rotation
075M	0.23 [0.5]	9.0 X 10 ⁵ [0.0008]	0.9 [8.3]	180°
094M	0.68 [1.5]	6.3 X 10 ⁴ [0.0056]	1.9 [17.3]	
106M	1.8 [4.0]	2.3 X 10 ³ [0.0207]	3.8 [33.2]	
131M	3.4 [7.5]	5.5 X 10 ³ [0.0485]	7.6 Nm [67.6]	

Size	Buna-N Seal Repair Kits	
	Body	Rotational Adjustment
075M	SLKT-210	SLKT-212
094M	SLKT-216	SLKT-218
106M	SLKT-222	SLKT-224
131M	SLKT-228	SLKT-230

Accessories

Sensor Accessories	Model Numbers	Part Number	Qty/Unit
NPN Magneto Resistive Sensor with Quick Disconnect*	All Models	OHSN-017	1-2
PNP Magneto Resistive Sensor with Quick Disconnect*	All Models	OHSP-017	1-2
NPN Magneto Resistive Sensor 90° Barrel with Quick Disconnect*	All Models	OHSN-011	1-2
PNP Magneto Resistive Sensor 90° Barrel with Quick Disconnect*	All Models	OHSP-011	1-2
Quick Disconnect 2 Meter Cable Length*	All Models	CABL-010	1-2
Quick Disconnect 5 Meter Cable Length*	All Models	CABL-013	1-2

Pneumatic Accessories	Model Numbers	Part Number	Qty/Unit
Fitting Push-in 90° Elbow G1/8, 6mm O.D. Tube	131M	PLFT-042	1-2
Fitting Push-in 90° Elbow G1/8, 8mm O.D. Tube	131M	PLFT-048	1-2
Fitting Push-in Straight G1/8, 6mm O.D. Tube	131M	PLFT-038	1-2
Fitting Push-in Straight G1/8, 8mm O.D. Tube	131M	PLFT-045	1-2
Flow Control Push-in 90° Elbow M5-6mm O.D. Tube**	075M, 094M, 106M	VLVF-008	1-2
Flow Control Push-in 90° Elbow G1/8-6mm O.D. Tube**	131M	VLVF-005	1-2

*Sensor and cable sold separately. **Flow Controls recommended for most applications

RR LIGHT-DUTY SERIES

Rotary Actuators

How To Order

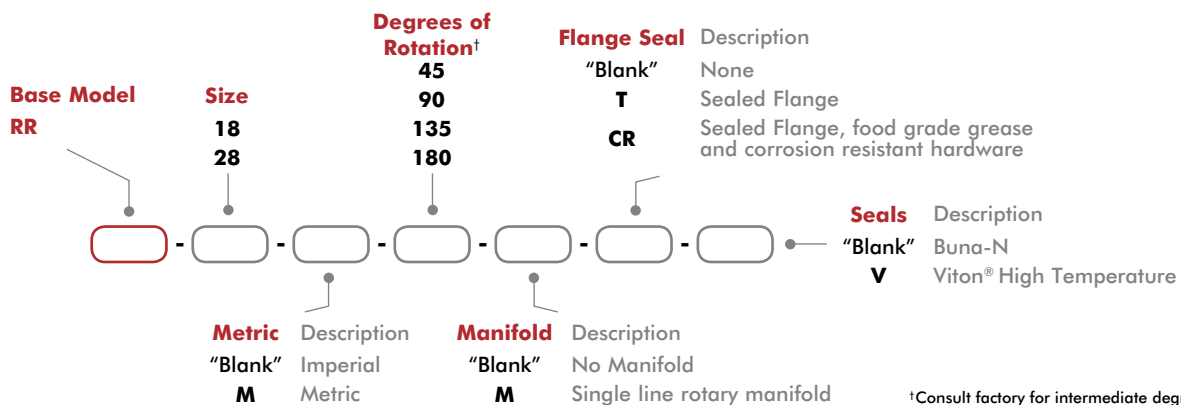

Size	Maximum Payload	Maximum Payload Inertia	Maximum Torque Mid-Stroke @ 100psi/7 bar	Maximum Torque End-Stroke @ 100psi/7 bar	Maximum Rotation
	kg [lb]	Nm sec ² [in-lbs sec ²]	Nm [lbs-in]	Nm [lbs-in]	
18	0.45 [1.0]	0.000181 [0.0016]	0.7 [6.5]	0.7 [6.5]	180°
28	1.36 [3.0]	0.001255 [0.0111]	2.5 [22]	2.5 [22]	

Size	Base Unit Seal Repair Kits		Bottom Air Port Manifold
	Buna-N	Viton®	Seal Kit - Viton®
18	SLKT-173	SLKT-173V	SLKT-174V
28	SLKT-175	SLKT-175V	SLKT-176V

Accessories

Sensor Accessories	Model Numbers	Part Number	Qty/Unit
Sensor Mounting Kit (mounts 2 sensors)	All Models	OSMK-024	1
NPN Inductive Sensor with Quick Disconnect*	All Models	OISN-014	1-2
PNP Inductive Sensor with Quick Disconnect*	All Models	OISP-014	1-2
Quick Disconnect 2 Meter Cable Length*	All Models	CABL-010	1-2
Quick Disconnect 5 Meter Cable Length*	All Models	CABL-013	1-2

Pneumatic Accessories	Model Numbers	Part Number	Qty/Unit
M3 Plumbing Fitting Push-In for 3mm OD Tube	All Models	PLFT-021	2
M3 Plumbing Fitting Barb for 2mm ID Tube	All Models	PLFT-022	2
#10-32 Flow Control (Imperial)	All Models	VLVF-007	2
M5 Flow Control	All Models	VLVF-008	2

*Sensor and cable sold separately.

RR MEDIUM-DUTY SERIES

Rotary Actuators

How To Order

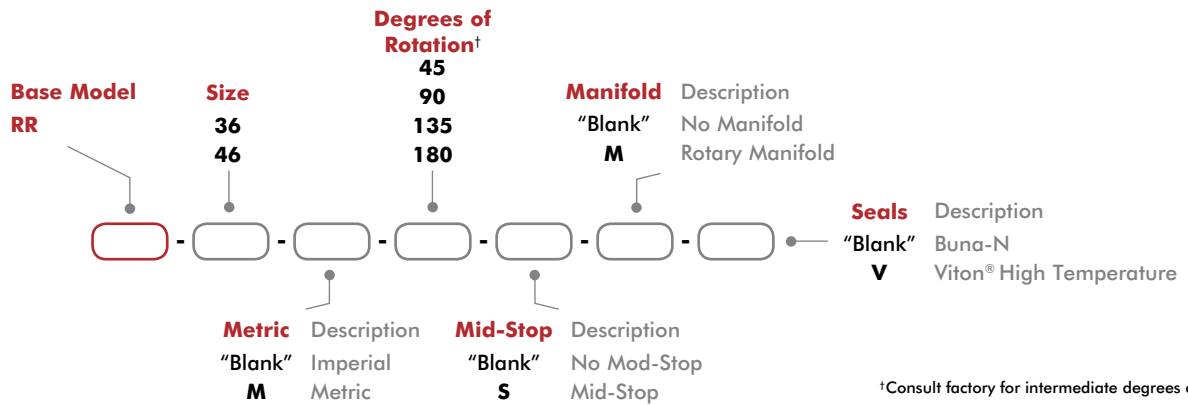

Size	Maximum Payload	Maximum Payload Inertia	Maximum Torque Mid-Stroke @ 100psi/7 bar	Maximum Torque End-Stroke @ 100psi/7 bar	Maximum Rotation
	kg [lb]	Nm sec ² [in-lbs sec ²]	Nm [lbs-in]	Nm [lbs-in]	
36	3.6 [8.0]	0.00468 [0.0414]	7.4 [65]	3.7 [32]	180°
46	6.8 [15]	0.01096 [0.0970]	14 [122]	7 [61]	

Size	Base Unit Seal Repair Kits		Manifold Seal Repair Kits		Mid-Stop Seal Repair Kits	
	Buna-N	Viton®	-M Buna-N	-M-V Viton®	-S Buna-N	-S-V Viton®
36	SLKT-016	SLKT-016V	SLKT-061	SLKT-061V	SLKT-062	SLKT-062V
46	SLKT-017	SLKT-017V	SLKT-067	SLKT-067V	SLKT-068	SLKT-068V

Accessories

Sensor Accessories	Model Numbers	Part Number	Qty/Unit
Sensor Mounting Kit (mounts 2 sensors)	All Models	OSMK-024	1
NPN Inductive Sensor with Quick Disconnect*	All Models	OISN-014	1-2
PNP Inductive Sensor with Quick Disconnect*	All Models	OISP-014	1-2
Quick Disconnect 2 Meter Cable Length*	All Models	CABL-010	1-2
Quick Disconnect 5 Meter Cable Length*	All Models	CABL-013	1-2

* Sensor and cable sold separately.

RR HEAVY-DUTY SERIES

Rotary Actuators

How To Order

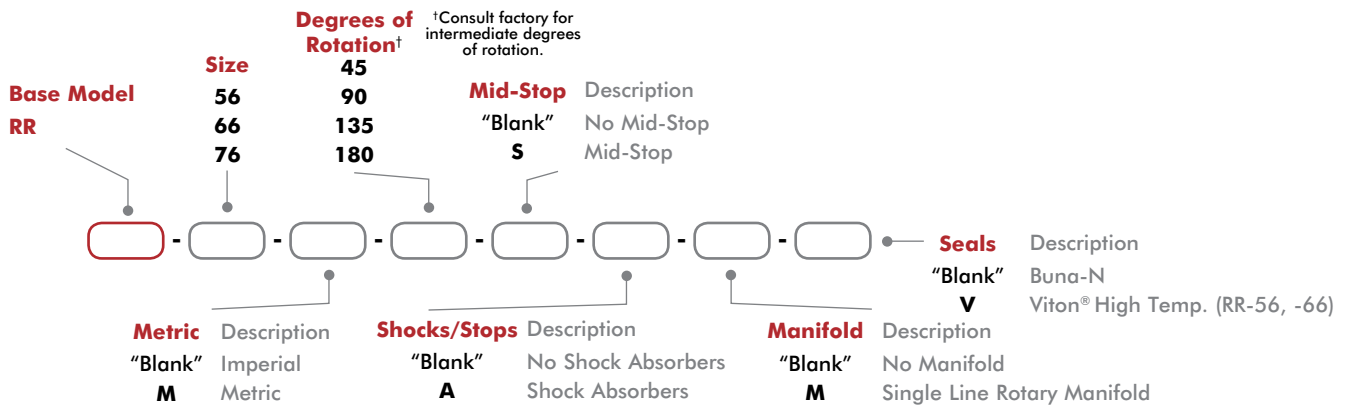

Size	Maximum Payload	Maximum Payload Inertia	Maximum Torque Mid-Stroke @ 100psi/7 bar	Maximum Torque End-Stroke @ 100psi/7 bar	Maximum Rotation
	kg [lb]	Nm sec ² [in-lbs sec ²]	Nm [lbs-in]	Nm [lbs-in]	
56	13.6 [30]	0.02880 [0.2549]	35 [311]	17 [155]	180°
66	34 [75]	0.11584 [1.0251]	82 [728]	41 [364]	
76	91 [200]	0.5596 [4.95]	215 [1900]	107 [950]	

[†]Max. payload based on -A shock option.

Size	Base Unit Seal Repair Kits		Manifold Seal Repair Kits		Mid-Stop Seal Repair Kits		Shock Seal Repair Kits	
	Buna-N	Viton®	-M Buna-N	-M-V Viton®	-S Buna-N	-S-V Viton®	-A Buna-N	-A-V Viton®
56	SLKT-124	SLKT-124V	SLKT-126	SLKT-126V	SLKT-127	SLKT-127V	SLKT-125	SLKT-125V
66	SLKT-128	SLKT-128V	SLKT-130	SLKT-130V	SLKT-131	SLKT-131V	SLKT-129	SLKT-129V
76	N/A	SLKT-167V	N/A	SLKT-169V	N/A	SLKT-168V	SLKT-179	N/A

RR HEAVY-DUTY SERIES

Rotary Actuators

Accessories

Sensor Accessories	Model Numbers	Part Number	Qty/Unit
Inductive Sensor Mounting Kit (mounts 2 sensors)	-56, -66	OSMK-075	1
Inductive Sensor Mounting Kit (mounts 2 sensors)	-76	OSMK-096	1
Magneto Resistive Sensor Mounting Kit (mounts 2 sensors)	-56, -66	OSMK-069	1
NPN Inductive Sensor with Quick Disconnect*	-56, -66	OISN-011	1-2
PNP Inductive Sensor with Quick Disconnect*	-56, -66	OISP-011	1-2
NPN Inductive Sensor with Quick Disconnect*	-76	OISN-017	1-2
PNP Inductive Sensor with Quick Disconnect*	-76	OISP-017	1-2
NPN Magneto Resistive Sensor with Quick Disconnect*	-56, -66	OHSN-017	1-2
PNP Magneto Resistive Sensor with Quick Disconnect*	-56, -66	OHSP-017	1-2
Quick Disconnect 2 Meter Cable Length*	-56, -66	CABL-010	1-2
Quick Disconnect 5 Meter Cable Length*	-56, -66	CABL-013	1-2
Quick Disconnect 2 Meter Cable Length*	-76	CABL-014	1-2
Quick Disconnect 5 Meter Cable Length*	-76	CABL-018	1-2

Pneumatic Accessories	Model Numbers	Part Number	Qty/Unit
1/4 NPT Flow Controls (Imperial)	-56	VLVF-009	2
G 1/4 BSPP Flow Controls	-56	VLVF-010	2
3/8 Flow Control (Imperial)	-66, -76	VLVF-011	2
G 3/8 BSPP Flow Control	-66, -76	VLVF-012	2
Adapter 1/8 NPT to G 1/8	-76	PLFT-028	1
Adapter 3/8 NPT to G 3/8	-76	PLFT-029	1

*Sensor and cable sold separately.

DLB SERIES - INTERNAL AIR CYLINDER

Internal Air Cylinder Linear Base Slides

How To Order

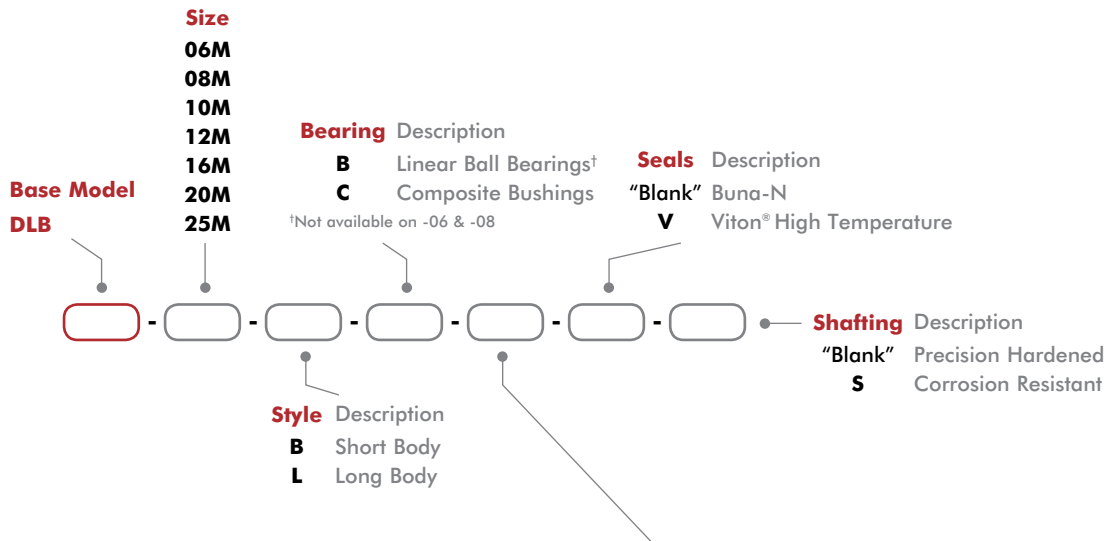
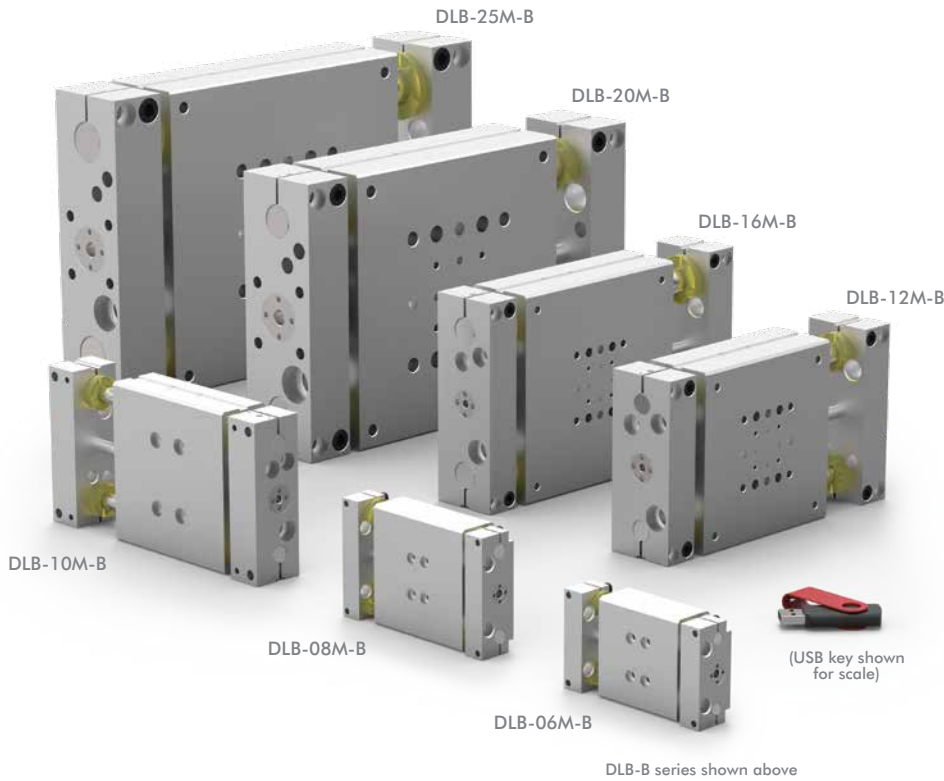

-B Style	Stroke* Metric (mm)
DLB-06M-B	6, 12, 25, 30
DLB-08M-B	6, 12, 25, 40, 44
DLB-10M-B	25, 50
DLB-12M-B	25, 50
DLB-16M-B	25, 50, 80
DLB-20M-B	25, 50, 80, 100
DLB-25M-B	25, 50, 80, 100, 125

-L Style	Stroke* Metric (mm)
DLB-06M-L	12, 25, 40, 50, 65, 75
DLB-08M-L	12, 25, 40, 50, 65, 75, 85
DLB-10M-L	25, 50, 80, 100
DLB-12M-L	25, 50, 80, 100, 125
DLB-16M-L	25, 50, 80, 100, 125, 150
DLB-20M-L	25, 50, 80, 100, 125, 160
DLB-25M-L	25, 50, 80, 100, 125, 160, 175

*Custom strokes available. Consult factory.

*Custom strokes available. Consult factory.

Size	Thrust Force @ 5.5 bar [80psi] N [lbs]
06-B, L	89 [20]
08-B, L	
10-B, L	129 [29]
12-B, L	254 [57]
16-B, L	
20-B, L	560 [126]
25-B, L	

DLB SERIES - INTERNAL AIR CYLINDER

Internal Air Cylinder Linear Base Slides

Shock/Stop Accessories	Model Numbers	Style	Part Number	Qty/Unit
Shock Absorber	06, 08	ALL	SHOK-030	1-2
	10		SHOK-028	
	12, 16,		SHOK-010	
	20, -25		SHOK-029	
Adjustable Hard Stop	06, 08		DLT-0623	
	10, 12, 16, 20, 25		DLT-1023	
Sensor Accessories	Model Numbers	Style	Part Number	Qty/Unit
PNP Inductive Sensor with Quick Disconnect*	All Models	ALL	OISP-011	1-2
NPN Inductive Sensor with Quick Disconnect*			OISN-011	
Quick Disconnect 2 Meter Cable Length*			CABL-010	
Quick Disconnect 5 Meter Cable Length*			CABL-013	
Pneumatic Accessories	Model Numbers	Style	Part Number	Qty/Unit
G1/8 Telescopic Airlines (up to 50mm)	10, 12, 16	B	OTAL-043	1-4
G1/8 Telescopic Airlines (up to 80mm)	10, 12, 16		OTAL-044	
G1/8 Telescopic Airlines (up to 100mm)	10, 12, 16	L	OTAL-051	
G1/8 Telescopic Airlines (up to 125mm)	10, 12, 16		OTAL-052	
G1/8 Telescopic Airlines (up to 160mm)	10, 12, 16, 20, 25	L	OTAL-045	
G1/8 Telescopic Airlines (up to 300mm)	20, 25		OTAL-046	
M5 Adjustable Flow Control	06, 08, 10, 12, 16		VLVF-008	1-2
G 1/8 Adjustable Flow Control	20, 25		VLVF-005	
Cylinder Seal Kit (Buna-N)	06, 08	ALL	SLKT-109	1
	10		SLKT-101	
	12, 16		SLKT-103	
	20, 25		SLKT-105	
Cylinder Seal Kit (Viton®)	06, 08		SLKT-109V	
	10		SLKT-101V	
	12, 16		SLKT-103V	
	20, 25		SLKT-105V	

*Sensor and cable sold separately.

See page GR-LIN-35 for Accessory Mounting Technical Data.

DLB SERIES - EXTERNAL AIR CYLINDER

External Air Cylinder Linear Base Slides

How To Order



	Size	Styles Available		Style	Description
	06M	T, U		T	Replaceable cylinder w/o adjustable air cushions
	08M	T, U		A	Replaceable cylinder with adjustable air cushions
	10M	A, U		N	Repairable VDMA cylinder w/adjustable air cushions
	12M	A, U		R	Repairable locking VDMA cylinder w/adjustable air cushions
	16M	A, U		U	Non-powered unit*
	20M	N, R, U			
	25M	N, R, U			

*Without cylinder. **Metric Units:** Mount VDMA cylinder directly.

Base Model										
DLB										

Size	Thrust Force @ 5.5 bar [80psi] N [lbs]
06-T, U	89 [20]
08-T, U	
10-A, U	145 [31]
12-A, U	
16-A, U	289 [65]
20-N, R, U	
25-N, R, U	443 [100]

Size	Style	Stroke* Metric (mm)
DLB-06M	T, U	10, 25, 40, 50, 75, 100, 125, 160
DLB-08M	T, U	10, 25, 40, 50, 75, 100, 125, 160, 175, 200
DLB-10M	A, U	25, 50, 80, 100, 125, 160, 200, 250, 300
DLB-12M	A, U	25, 50, 80, 100, 125, 160, 200, 250, 300, 320, 360, 400
DLB-16M	A, U	25, 50, 80, 100, 125, 160, 200, 250, 300, 320, 360, 400, 500
DLB-20M	N, R, U	25, 50, 80, 100, 125, 160, 200, 250, 300, 320, 360, 400, 500
DLB-25M	N, R, U	25, 50, 80, 100, 125, 160, 200, 250, 300, 320, 360, 400, 500

*Custom strokes available. Consult factory.

DLB SERIES - EXTERNAL AIR CYLINDER

External Air Cylinder Linear Base Slides

Shock/Stop Accessories	Model Sizes	Style	Part Number	Qty/Unit
Shock Absorber	06, 08	All	SHOK-030	1-2
	10		SHOK-028	
	12, 16,		SHOK-010	
	20, 25		SHOK-029	
Adjustable Hard Stop	06, 08		DLT-0623	
	10, 12, 16, 20, 25		DLT-1023	

Sensor Accessories	Model Sizes	Style	Part Number	Qty/Unit
PNP Inductive Sensor with Quick Disconnect*	All Models	All	OISP-011	1-2
NPN Inductive Sensor with Quick Disconnect*			OISN-011	
PNP Magneto Resistive Sensor w/Qk Disconnect*	06, 08, 10, 12, 16	T, A	OHSP-005	
NPN Magneto Resistive Sensor w/Quick Disconnect*			OHSN-005	
PNP Magneto Resistive Sensor w/Qk Disconnect*	20, 25	N, R	OHSP-020	
NPN Magneto Resistive Sensor w/Qk Disconnect*			OHSN-020	
Quick Disconnect 2 Meter Cable Length*	All Models	All	CABL-010	
Quick Disconnect 5 Meter Cable Length*			CABL-013	
Cable Extension Cord 1M Length*	All Models	All	CABL-015	
Cable Extension Cord 2M Length*			CABL-016	

Pneumatic Accessories	Model Sizes	Style	Part Number	Qty/Unit
G1/8 Telescopic Airlines (up to 160mm)	10, 12, 16	All	OTAL-045	1-4
G1/8 Telescopic Airlines (up to 300mm)	10, 12, 16		OTAL-046	
G1/8 Telescopic Airlines (up to 450mm)	10, 12, 16, 20, 25		OTAL-047	
G1/8 Telescopic Airlines (up to 600mm)	20M, 25M		OTAL-048	
G1/8 Adjustable Flow Control	10, 12, 16, 20, 25		VLVF-005	1-2
G1/8 Male to 1/8 NPT Adapter	20, 25	PLFT-025		

*Sensor and cable sold separately.

See page GR-LIN-35 for Accessory Mounting Technical Data.

DLT SERIES - INTERNAL AIR CYLINDER

Internal Air Cylinder Linear Thruster Slides

How To Order

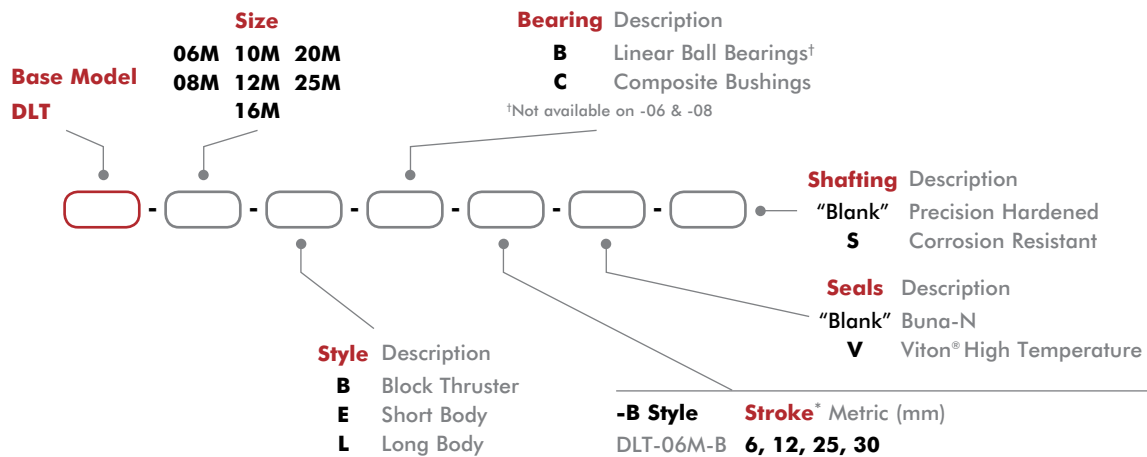
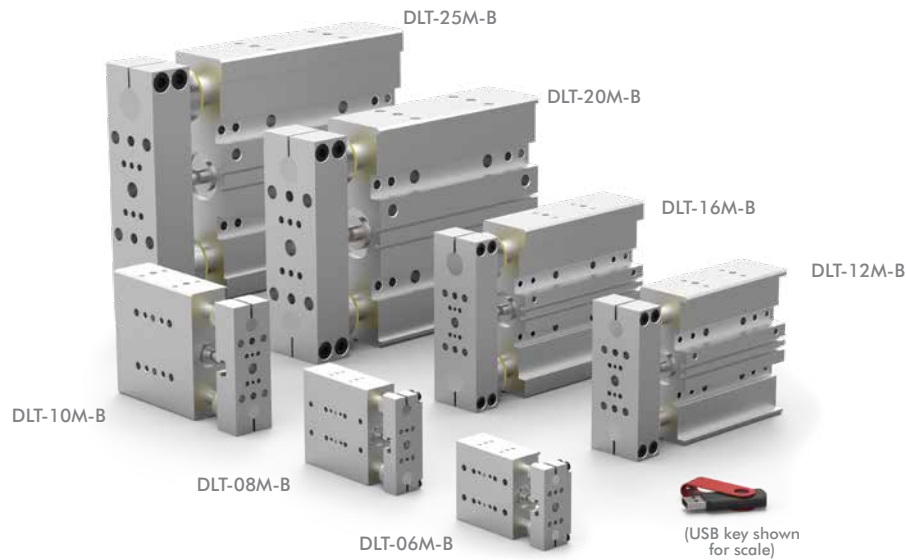

Size	Thrust Force @ 5.5 bar [80psi] N [lbs]
06-B, E, L	89 [20]
08-B, E, L	155 [35]
10-B, E, L	275 [62]
12-B, E, L	622 [140]
16-B, E, L	
20-B, E, L	
25-B, E, L	

Size	Base Flange Kit (-B Only)	Cylinder Seal Kits	
		Buna-N	Viton®
06-B, E, L	ODLT-015	SLKT-108	SLKT-108V
08-B, E, L	ODLT-016		
10-B, E, L	ODLT-006	SLKT-100	SLKT-100V
12-B, E, L	ODLT-008	SLKT-102	SLKT-102V
16-B, E, L	ODLT-010		
20-B, E, L	ODLT-012	SLKT-104	SLKT-104V
25-B, E, L	ODLT-014		

-B Style	Stroke* Metric (mm)
DLT-06M-B	6, 12, 25, 30
DLT-08M-B	6, 12, 25, 30, 40, 44
DLT-10M-B	12, 25, 40, 50
DLT-12M-B	12, 25, 40, 50
DLT-16M-B	12, 25, 40, 50, 65, 75
DLT-20M-B	12, 25, 40, 50, 65, 75, 85, 100
DLT-25M-B	12, 25, 40, 50, 65, 75, 85, 100, 115, 125

-E Style	Stroke* Metric (mm)
DLT-06M-E	6, 12, 25, 30
DLT-08M-E	6, 12, 25, 40, 44
DLT-10M-E	25, 50
DLT-12M-E	25, 50
DLT-16M-E	25, 50, 75
DLT-20M-E	25, 50, 75, 100
DLT-25M-E	25, 50, 75, 100, 125

-L Style	Stroke* Metric (mm)
DLT-06M-L	12, 25, 40, 50, 65, 75
DLT-08M-L	12, 25, 40, 50, 65, 75, 85
DLT-10M-L	25, 50, 80, 100
DLT-12M-L	25, 50, 80, 100, 125
DLT-16M-L	25, 50, 80, 100, 125, 150
DLT-20M-L	25, 50, 75, 100, 125, 160
DLT-25M-L	25, 50, 75, 100, 125, 160, 175

*Custom strokes available. Consult factory.

DLT SERIES - INTERNAL AIR CYLINDER

Internal Air Cylinder Linear Thruster Slides

Shock/Stop & Mounting Accessories	Model Numbers	Style	Part Number	Qty/Unit
Universal Mounting Kit (Stop/Shock)	06	All	OSAK-069	1-2 on -B 1-4 on -E, -L
	08		OSAK-070	
Universal Mounting Kit (Stop/Shock/Sensor)	10		OSAK-055	
	12		OSAK-057	
	16		OSAK-059	
	20		OSAK-061	
	25		OSAK-063	
	06, 08		SHOK-030	
Shock Absorber	10		SHOK-028	
	12, 16,		SHOK-010	
	20, 25		SHOK-029	
	06, 08		DLT-0623	
Adjustable Hard Stop	10, 12, 16, 20, 25		DLT-1023	
	06		OSAK-067	
Urethane Bumper/Stop Collar Kit	08	OSAK-068		
	10	OSAK-065		
	12	OSAK-066		
	16	OSAK-060		
	20	OSAK-062		
	25	OSAK-064		
Base Flange Kit	See Datasheet	B	--	

Sensor Accessories	Model Numbers	Style	Part Number	Qty/Unit	
Inductive Sensor Mounting Kit	06	All	OSMK-076	1 on -B 1-2 on -E, -L	
	08		OSMK-077		
PNP Inductive Sensor with Quick Disconnect*	06, 08		OISP-014		
NPN Inductive Sensor with Quick Disconnect*			OISN-014		
PNP Inductive Sensor with Quick Disconnect*	10, 12, 16, 20, 25		OISP-011		
NPN Inductive Sensor with Quick Disconnect*			OISN-011		
PNP Magneto Resistive with Quick Disconnect*	All Models		OHSP-017		1-2
NPN Magneto Resistive with Quick Disconnect*			OHSN-017		
Quick Disconnect 2 Meter Cable Length*	All Models		CABL-010		
Quick Disconnect 5 Meter Cable Length*			CABL-013		

*Sensor and cable sold separately.

Pneumatic Accessories	Model Numbers	Style	Part Number	Qty/Unit
G1/8 Telescopic Airlines (up to 50mm)	10, 12, 16	B, E	OTAL-043	1-4
G1/8 Telescopic Airlines (up to 80mm)		B, E, L	OTAL-044	
G1/8 Telescopic Airlines (up to 100mm)	20, 25	B, E	OTAL-051	
G1/8 Telescopic Airlines (up to 125mm)		B, E	OTAL-052	
G1/8 Telescopic Airlines (up to 160mm)	10, 12, 16	L	OTAL-045	
G1/8 Telescopic Airlines (up to 300mm)	20, 25		OTAL-046	
M5 Adjustable Flow Control	06, 08, 10, 12, 16	All	VLVF-008	1-2
G1/8 Adjustable Flow Control	20, 25		VLVF-005	
Seal Kits	See Datasheets			1

DLT SERIES - EXTERNAL AIR CYLINDER

External Air Cylinder Linear Thruster Slides

How To Order

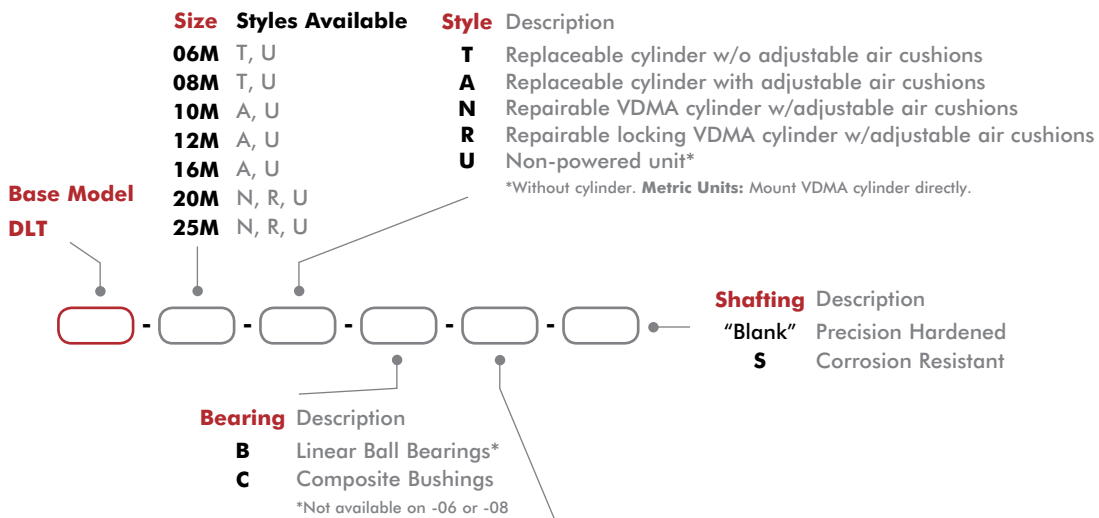
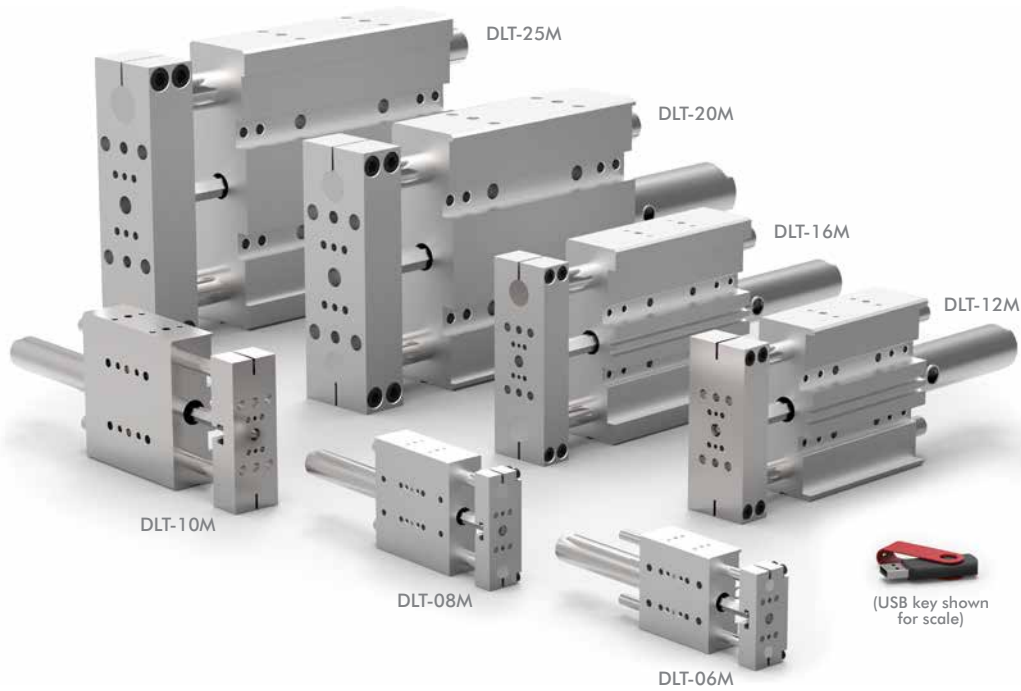

Size	Thrust Force @ 5.5 bar [80psi] N [lbs]
06-T, U	89 [20]
08-T, U	
10-A, U	155 [35]
12-A, U	270 [70]
16-A, U	
20-N, R, U	443 [140]
25-N, R, U	

Size	Style	Stroke* Metric (mm)
DLT-06M	T, U	10, 25, 40, 50, 75, 100, 125, 160
DLT-08M	T, U	10, 25, 40, 50, 75, 100, 125, 160, 175, 200
DLT-10M	A, U	25, 50, 80, 100, 125, 160, 200, 250, 300
DLT-12M	A, U	25, 50, 80, 100, 125, 160, 200, 250, 300, 320, 360, 400
DLT-16M	A, U	25, 50, 80, 100, 125, 160, 200, 250, 300, 320, 360, 400, 500
DLT-20M	N, R, U	25, 50, 80, 100, 125, 160, 200, 250, 300, 320, 360, 400, 500
DLT-25M	N, R, U	25, 50, 80, 100, 125, 160, 200, 250, 300, 320, 360, 400, 500

*Custom strokes available. Consult factory.

DLT SERIES - EXTERNAL AIR CYLINDER

External Air Cylinder Linear Thruster Slides

Shock/Stop & Mounting Accessories	Model Numbers	Style	Part Number	Qty/Unit
Universal Mounting Kit (Stop/Shock)	06	All	OSAK-069	1-4
	08		OSAK-070	
Universal Mounting Kit (Stop/Shock/Sensor)	10		OSAK-055	
	12		OSAK-057	
	16		OSAK-059	
	20		OSAK-061	
	25		OSAK-063	
	06, 08		SHOK-030	
Shock Absorber (2 Max on -06)	10		SHOK-028	
	12, 16,		SHOK-010	
	20, 25		SHOK-029	
Adjustable Hard Stop	06, 08		DLT-0623	
	10, 12, 16, 20, 25		DLT-1023	
Urethane Bumper/Stop Collar Kit	06		OSAK-067	
	08	OSAK-068		
	10	OSAK-065		
	12	OSAK-066		
	16	OSAK-060		
	20	OSAK-062		
	25	OSAK-064		

Sensor Accessories	Model Numbers	Style	Part Number	Qty/Unit
Inductive Sensor Mounting Kit	06	T	OSMK-076	1
Inductive Sensor Mounting Kit	08		OSMK-077	
PNP Inductive Sensor with Quick Disconnect*	06, 08,	T	OISP-014	
NPN Inductive Sensor with Quick Disconnect*			OISN-014	
PNP Inductive Sensor with Quick Disconnect*	10, 12, 16, 20, 25	A, N, R	OISP-011	1-2
NPN Inductive Sensor with Quick Disconnect*			OISN-011	
PNP Magneto Resistive Sensor w/Qk Disconnect*	06, 08, 10, 12, 16	T, A	OHSP-005	
NPN Magneto Resistive Sensor w/Qk Disconnect*			OHSN-005	
PNP Magneto Resistive Sensor w/Qk Disconnect*	20, 25	N, R	OHSP-020	
NPN Magneto Resistive Sensor w/Qk Disconnect*			OHSN-020	
Quick Disconnect 2 Meter Cable Length*	All Model	All	CABL-010	
Quick Disconnect 5 Meter Cable Length*			CABL-013	
Cable Extension Cord 1M Length*	All Models	All	CABL-015	
Cable Extension Cord 2M Length*			CABL-016	

Pneumatic Accessories	Model Numbers	Style	Part Number	Qty/Unit
VDMA Cylinder Mounting Kit	20, 25	U	ODLT-004	1
G1/8 Telescopic Airlines (up to 160mm)	10, 12, 16, 20, 25	All	OTAL-045	1-4
G1/8 Telescopic Airlines (up to 300mm)			OTAL-046	
G1/8 Telescopic Airlines (up to 450mm)			OTAL-047	
G1/8 Telescopic Airlines (up to 600mm)			OTAL-048	
M5 Adjustable Flow Control			06, 08	
G1/8 Adjustable Flow Control	10, 12, 16, 20, 25		VLVF-005	1-2
M5 Retract Port Standoff			06, 08	

*Sensor and cable sold separately.

DLM SERIES

Miniature Rail Thruster Slide

How To Order

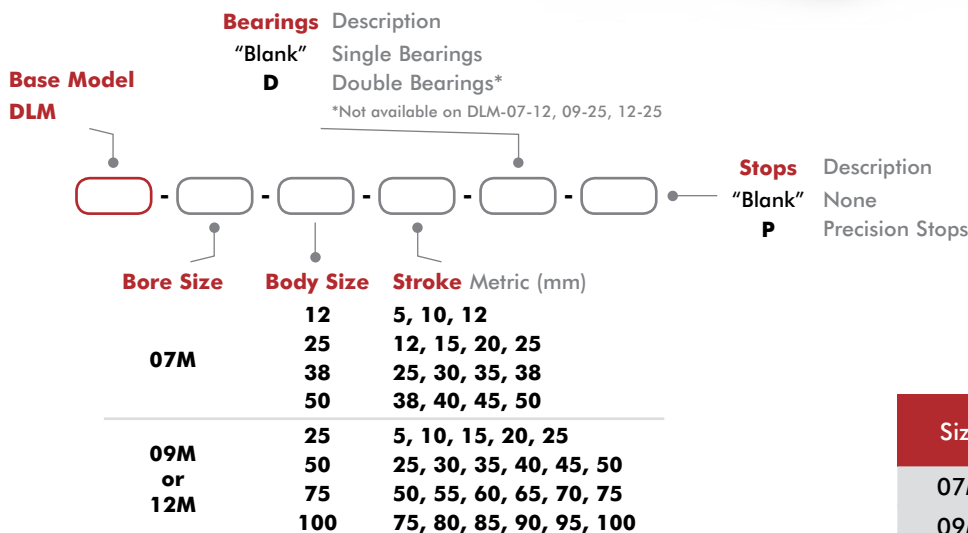
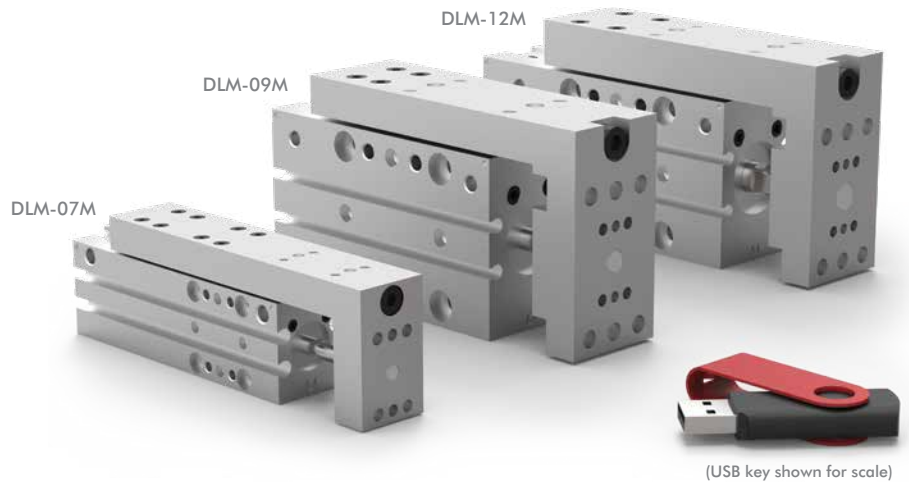

Size	Seal Repair Kits	
	Base Buna-N	Manifold Kit
07M		
09M	SLKT-237	SLKT-240
09M	SLKT-238	

Size	Thrust Force F @ 7 bar [100 psi]	Max Stroke mm [in]	Size	Thrust Force F @ 7 bar [100 psi]	Max Stroke mm [in]	Size	Thrust Force F @ 7 bar [100 psi]	Max Stroke mm [in]
07M-12	66 [15]	12 [0.50]	09M-25	138 [31]	25 [1.00]	12M-25	230 [51]	25 [1.00]
07M-25		25 [1.00]	09M-50		50 [2.00]	12M-50		50 [2.00]
07M-38		38 [1.50]	09M-75		75 [3.00]	12M-75		75 [3.00]
07M-50		50 [2.00]	09M-100		100 [4.00]	12M-100		100 [4.00]

Accessories

Sensor Accessories	Model Numbers	Part Number	Qty/Unit
PNP Magneto Resistive Sensor Short Barrel (with Qk. Disc.)*	All Models	OHSP-017	1-4
NPN Magneto Resistive Sensor Short Barrel (with Qk. Disc.)*	All Models	OHSN-017	1-4
PNP Magneto Resistive Sensor 90° Barrel (with Qk. Disc.)*	All Models	OHSP-011	1-4
NPN Magneto Resistive Sensor 90° Barrel (with Qk. Disc.)*	All Models	OHSN-011	1-4
Quick Disconnect 2 Meter Cable Length*	All Models	CABL-010	1-4
Quick Disconnect 5 Meter Cable Length*	All Models	CABL-013	1-4

Pneumatic Accessories	Model Numbers	Part Number	Qty/Unit
Adjustable Flow Control	All Models	VLFL-008	1-2
Seal Kits	See Datasheets		1

* Sensor and cable sold separately.

MPS SERIES

Miniature Rail Thruster Slide

How To Order

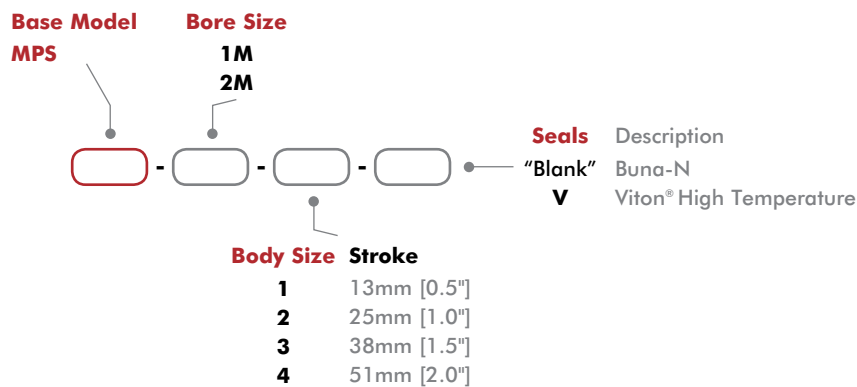
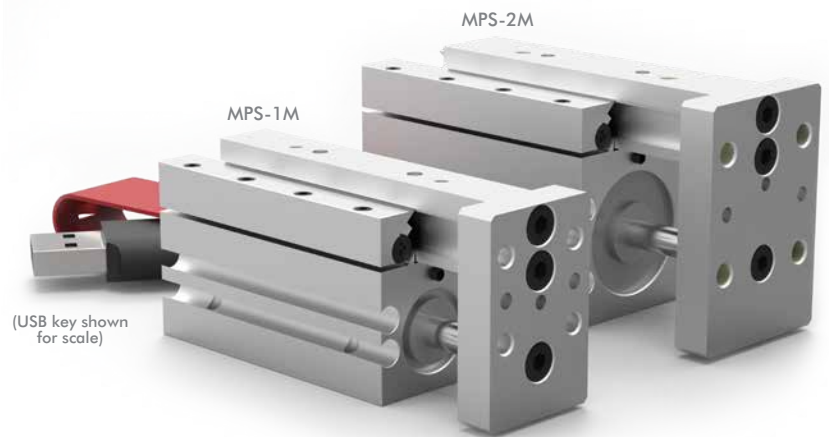

Size	Thrust Force F @ 7 bar [100 psi]	Max Stoke mm [in]	Size	Thrust Force F @ 7 bar [100 psi]	Max Stoke mm [in]
1M-1	67 [15]	13 [0.50]	2M-1	196 [44]	13 [0.50]
1M-2		25 [1.00]	2M-2		25 [1.00]
1M-3		38 [1.50]	2M-3		38 [1.50]
1M-4		51 [2.00]	2M-4		51 [2.00]

Accessories

Sensor Accessories	Model Numbers	Part Number	Qty/Unit
Magneto Resistive Sensor with Quick. Disconnect*	All Models	OHSN-006	1-2
Magneto Resistive Sensor with Quick. Disconnect*		OHSP-006	
Quick Disconnect 2 Meter Cable Length*		CABL-010	
Quick Disconnect 5 Meter Cable Length*		CABL-013	
Pneumatic Accessories	Model Numbers	Part Number	Qty/Unit
M5 Adjustable Flow Control	All Models	VLVF-008	1-2
M2.5 Barbed Fitting		PLFT-005	2
Seal Kit (Buna-N)	-1M	SLKT-090	1
Seal Kit (Viton®)	-1M	SLKT-090V	
Seal Kit (Buna-N)	-2M	SLKT-091	
Seal Kit (Viton®)	-2M	SLKT-091V	

*Sensor and cable sold separately.

RFE SERIES

Feed Escapements

How To Order

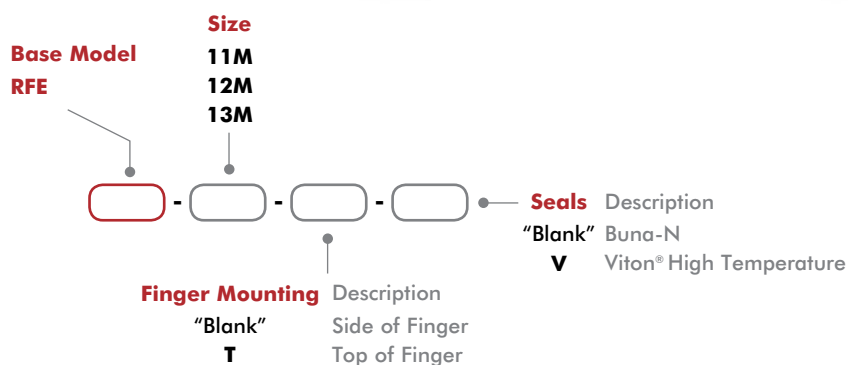
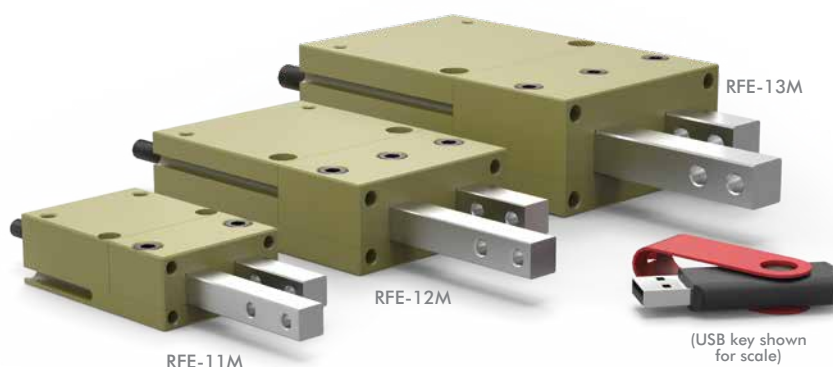

Size	Thrust Force at 7 bar [100 psi]	Stroke mm [in]
11M	111 [25]	15.88 [0.625]
12M	222 [50]	25.40 [1.000]
13M	31.75 [1.250]	31.75 [1.250]

Size	Seal Repair Kits	
	Buna-N	Viton®
11M	SLKT-110	SLKT-110V
12M	SLKT-111	SLKT-111V
13M	SLKT-112	SLKT-112V

Accessories

Sensor Accessories	Model Numbers	Part Number	Qty/Unit
NPN Hall Effect Sensor with Quick Disconnect*	All Models	OHSN-017	1-2
PNP Hall Effect Sensor with Quick Disconnect*	All Models	OHSP-017	1-2
Quick Disconnect 2 Meter Cable Length*	All Models	CABL-010	1-2
Quick Disconnect 5 Meter Cable Length*	All Models	CABL-013	1-2

Pneumatic Accessories	Model Numbers	Part Number	Qty/Unit
M5 Adjustable Flow Control	All Models	VLVF-008	1-2

*Sensor and cable sold separately.

How To Order

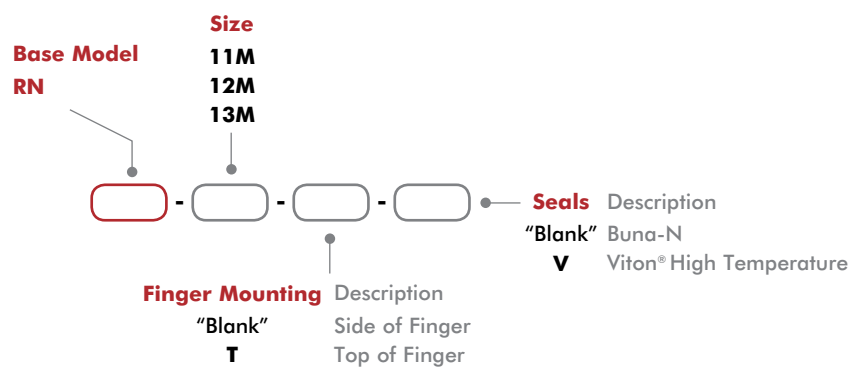
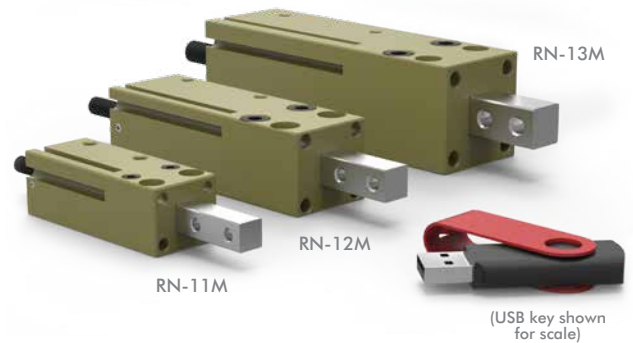

Size	Thrust Force at 7 bar [100 psi]	Stroke mm [in]	Seal Repair Kits	
			Buna-N	Viton®
11M	111 [25]	15.88 [0.625]	SLKT-114	SLKT-114V
12M	222 [50]	25.40 [1.000]	SLKT-115	SLKT-115V
13M	31.75 [1.250]	31.75 [1.250]	SLKT-116	SLKT-116V

Accessories

Sensor Accessories	Model Numbers	Part Number	Qty/Unit
NPN Hall Effect Sensor with Quick Disconnect*	All Models	OHSN-006	1-2
PNP Hall Effect Sensor with Quick Disconnect*	All Models	OHSP-006	1-2
Quick Disconnect 2 Meter Cable Length*	All Models	CABL-010	1-2
Quick Disconnect 5 Meter Cable Length*	All Models	CABL-013	1-2

Pneumatic Accessories	Model Numbers	Part Number	Qty/Unit
M5 Adjustable Flow Control	All Models	VLVF-008	1-2

* Sensor and cable sold separately.

DESTACO EUROPE - DISTRIBUTORS

AUSTRIA

Flohr Industrietechnik Austria
t: +0043 (0) 5572 372 158
e: info@flohr.at

BELARUS

IOOO RIVAL SVARKA
t: +375 17 385 15 75
e: wojciech.wierzba@rywal.com.pl

BOSNIA & HERZEGOVINA

See Halder d.o.o., Slovenia

BULGARIA

Kammarton Bulgaria Ltd.
t: +359 2926 6060
e: borislava.tasseva@kammarton.com

CROATIA

See Halder d.o.o., Slovenia

CZECH REPUBLIC

DESTACO
Martin Lukes
t: +420 603 577 341
e: mlukes@destaco.com

EXACTEC

t: +42 485 151 447
e: info@exactec.com

PROEXPO plus, s.r.o.

t: +42 0 317 7 01 102
e: jstepan@proexpoplus.cz

See D-S-C Slovensko s.r.o.,
Repubblica Slovacchia

DENMARK

Norm-Teknik as
t: +45 74560100
e: nt@norm-technik.dk

EGYPT

Integrated Equipment Company
t: +20 22 350 8915
e: ieco@link.net

ESTONIA

See Rywal RHC, Poland

FINLAND

Teräskonttori Oy
t: +358 9 615 471
e: info@teraskonttori.fi

FRANCE

Fenwick S.A.
t: +33 1 40 10 67 00
e: cpittioni@fenwick.fr

GERMANY

Altmann GmbH & Co. KG
t: +0049 8131 31590 0
e: info@altmann-industrietechnik.de

Boie GmbH Fachgroßhandel

t: +0049 8131 315900
e: info@boie.de

Druckluft Koenitzer GmbH & Co. KG

t: +0049 9123 9424 0
e: info@druckluft-koenitzer.de

ERIKS Deutschland GmbH

t: +0049 3944 95476 0
e: bielefeld@eriks.de

Faber Industrietechnik GmbH

t: +0049 621 844820
e: kontakt@faber-industrietechnik.de

Firnrohr Automation

Vertriebs GmbH
t: +0049 2932 97620
e: info@firmrohr-automation.de

FLOHR Industrietechnik GmbH

t: +0049 7751 87310
e: info@flohr-industrietechnik.de

Leschhorn GmbH & Co. KG

t: +0049 69 4209760
e: info@leschhorn.de

Nölle + Nordhorn GmbH

t: +0049 5241 8606 0
e: info@nngt.de

Schroers Werkzeuge

t: +0049 2153 9107690
e: info@schroers-werkzeuge.com

SCHWARK Hydraulik & Pneumatik OHG

t: +0049 2721 95710
e: mail@schwark.ag

Walter Ruff GmbH

t: +0049 421 438780
e: mail@praezruff.de

GREECE

MEK Maria Koutseris & Co.
t: +30 210 52 20 557-559
e: info@mek.com.gr

HUNGARY

IPT Kereskedelmi Kft.
(Automation Products)
t: +36 88 565 803
e: rendeles@iptker.hu

Kiraly Trading Hungary GmbH

t: +36 13 07 38 00
e: kiraly@kiralytrading.hu

ISRAEL

BARMIL LTD
t: +972 3 9240196
e: shmuels@barmil.co.il

DOR Engineering

(Automation Products)
t: +972 3 9240196
e: info@doreng.co.il

ITALY

IBD srl
t: +972 (0) 54-4247348
e: commerciale@ibdonline.org

LITHUANIA

UAB "Rywal LT"
t: +37 37 473235
e: wojciech.wierzba@rywal.com.pl

MACEDONIA

See Halder d.o.o., Slovenia

MOLDOVA

See SC Parcon SRL, Romania

MONTENEGRO

See Halder d.o.o., Slovenia

NORWAY

Bergsli Hantek A.S.
t: +47 35 50 35 00
e: kran.handtering@bergsli.no

POLAND

DESTACO
Maciej Pelka
t: +48 50 600 21 15
e: mpelka@destaco.com

Cloos Polska Sp. z o.o.

t: +48 74 851 86 -60 or -76
e: t.jastrzebski@cloos.pl

Festo Polska Sp. Zo.o.

t: +48 22 72 04 166
e: Ireneusz_Gwizdowski@festo.com

Radius Radpol

(Ferguson, Indexer)
t: +48 22 72 04 166
e: info@radius-radpol.com.pl

Rywal RHC

t: +48 56 66 93 821 or 800
e: wojciech.wierzba@rywal.com.pl

PORTUGAL

SUTAfer Rep. de Normalizados
e Ferramentas
t: +351 256 660690
e: sutafer@sutafer.com

ROMANIA

SC Parcon SRL
t: +40 265 253 088
e: comert@parcon.ro

RUSSIA

OOO "Festo.RF"
t: +7 495 737 3400
e: festo@festo.ru

VEKTOR GRUPP Ltd

t: +7 495 787 49 12
e: info@vektor-grupp.ru

See Rywal RHC, Poland

SERBIA

See Halder d.o.o., Slovenia

SLOVAK REPUBLIC

D-S-C Slovensko s.r.o.
t: +421 908 912 557
e: licko@dscslovensko.sk

SLOVENIA

Halder d.o.o.
t: +38 62 61 82 646
e: danilo.zgrabic@halder.si

SOUTH AFRICA

Clamping Technology
t: +27 82 576 7510
e: info@clampingtechnology.co.za

SWEDEN

DESTACO Svenska AB
t: +46 31 691510
e: andreas.brandt@destaco.se

SWITZERLAND

Flohr Industrietechnik
t: +0041 (0) 56 267 08 10
e: info@flohr.ch

TURKEY

DSC Mekatronik LTD. STI
t: +90 224 443 4680-81
e: info@dsc.com.tr

RMK Mekatronik Makina San.

Tic. Ltd. ti. (Automation Products)
t: +0090 224 441 21 62
e: rmk@rmkmakina.com

UKRAINE

See Rywal RHC, Poland

UNITED ARAB EMERATES

YES Machinery
t: +00971 65264382
e: sales@yesmachinery.ae



GLOBAL LOCATIONS

EUROPE

Germany
Tel: +49-6171-705-0
Customer Service: europa@destaco.com

France
Tel: +33-4-7354-5001
Customer Service: france@destaco.com

UK
Tel: +44-1902-797980
Customer Service: uk@destaco.com

Spain
Tel: +34-936361680
Customer Service: spain@destaco.com

Benelux
Tel: +31-297285332
Customer Service: benelux@destaco.com

ASIA

Thailand
Tel: +66-2-326-0812
Customer Service: info@destaco.com

China
Tel: +86-21-6081-2888
Customer Service: china@destaco.com

India
Tel: +91-80-41123421-426
Customer Service: india@destaco.com

NORTH AMERICA

Corporate Headquarters
Auburn Hills, Michigan
Toll Free: 1.888.DESTACO
Marketing: marketing@destaco.com

Global Technology Center
Auburn Hills, Michigan
Tel: 1.248.836.6700
Customer Service: customerservice@destaco.com

Mt. Juliet, Tennessee
Tel: 1.888.DESTACO
Customer Service: customerservice@destaco.com

Wheeling, Illinois
Tel: 1.800.645.5207
Customer Service: camco@destaco.com

Red Wing, Minnesota (Central Research Laboratories)
Tel: 651.385.2142
Customer Service: sales@centres.com

THE UNIVERSITY OF CHICAGO PRESS